



s82 Mark II Streaming DAC and Roon Server

Owner's Manual

PLEASE READ BEFORE OPERATION



DSD
Direct Stream Digital

DXD
Digital eXtreme Definition



DSD 512/24.576 MHz

PCM 32bit/384 kHz

MQA 24 bit/384 kHz

roonroonroon
ready tested core

REV. 2.0.4 – 06/2023

Table of Contents

Table of Contents.....	2
Welcome	5
Package Contents.....	6
Proper Device Placement.....	6
Overview	7
Features for Sonic Fidelity.....	8
Front and Rear Panels.....	10
Infrared Remote Control.....	11
Connecting the s82 Mark II Streaming DAC and Roon Server	12
Connecting the Digital Inputs	12
Connecting the Line Outputs	12
Connecting TV, USB keyboard and Mouse (Optional)	12
Trigger Output.....	13
Direct Connection to Analogue Power Amplifier.....	13
Power Supply	13
Single Power Supply Configuration.....	13
Connecting Additional Linear Power Supply for the DAC Analogue Stages	13
Surge Protectors	14
Isolating the Cable TV Ground	14
How to Use the s82 Mark II streaming DAC and Roon Server	15
Roon Ready Network Player	15
Tidal Connect Player	15
USB ASIO DAC	16
UPnP /OpenHome Player and Audio Library Server.....	16
Network Audio Adapter for HQPlayer	16
AirPlay Player	16
Bluetooth Music Player.....	16
Web Streaming Player	17
Playing Music from Stereo SPDIF Sources	17
Quick Start Guide	18
Proper Device Placement.....	18
Initial Start-up	18
Configuring a Wi-Fi Connection to the Home Network (Optional).....	18
Using the exaSound s82 Mark II with Roon	19

Using the exaSound s82 Mark II with Tidal Connect	19
Using the exaSound s82 Mark II with UPnP.....	19
Using the exaSound s82 Mark II with HQPlayer	19
Using the exaSound s82 Mark II with AirPlay	20
Windows ASIO Driver Setup	21
exaSound Dashboard (Windows).....	21
s82 Mark II Configuration	22
Input Selection	24
Device Information	24
Firmware Updates.....	25
Settings Menu	26
Wi-Fi Configuration	26
Multi-room Configuration and Using a Custom Device Name	28
Ethernet Connection with Manual IP Address.....	29
Switching Between Wireless and Wired Network Connection.....	30
Resetting the Network Connection to Factory Defaults.....	30
Sharing Connected USB Drives on the Network	31
General Settings Page	33
Power Saving Mode Timeout.....	34
Advanced Settings - Audio Optimisations.....	34
Advanced Settings - SPDIF and TOSLINK Lock.....	35
Advanced Settings - DAC Reset and Line Outputs control.....	36
Volume Control for LAN, SPDIF and Optical Inputs	37
Volume Bypass.....	38
Maximum Volume Limit.....	39
UPnP Server and Music Library.....	40
CD Ripping.....	41
Bluetooth Audio Streaming	43
Web Streaming via HDMI - Experimental	44
Remote Support and Help.....	45
Remote support connections.....	45
Windows ASIO Drivers Step-by-step Setup Guide	46
PC System Requirements.....	46
Windows ASIO Driver Installation.....	46

Using the s82 DAC with USB connection to Windows Computer.....	51
Using the Asynchronous USB Input - Windows	51
JRiver / JRemote Volume Synchronization Plug-in - Windows	52
Roon Volume Synchronization Plug-in - Windows	53
Step-By-Step Player Configuration Instructions - Windows	53
Using Player Apps without ASIO Support	53
Playing Music from SPDIF Sources.....	54
IR Remote Control Setup	55
Specifications	56
Open-source Credits	59
GNU General Public License (“GPL”).....	59
Safety Information	60
Explanation of Graphical Symbols	60
Important Safety Instructions.....	60
Precautions	60
Limited One Year Warranty	63

Welcome

Thank you for purchasing the exaSound s82 Mark II Streaming DAC and Roon Server. Combining a reference-grade 32-bit digital-to-analog converter and Roon Ready streamer and server in one elegant component, the s82 Mark II brings simplicity and sonic perfection to your music room.

The two models of the exaSound s82 Streaming DAC, Mark I and Mark II are identical in terms of sound fidelity, appearance and refinements.

The defining feature of the Mark II upgrade is the server/streamer module for hosting a Roon Core. s82 Mark II is a reference grade all-in-one-box, easy-to-use solution for Roon: DAC, streamer and server.

With refinements like autonomous balanced and unbalanced I/V stages and exaSound's unique three-way galvanic isolation, s82 Mark II Streaming DAC will uncover every detail in your high-resolution files, allowing you to hear the music just as it was recorded.

s82 Mark II features proprietary asynchronous USB and network streaming, Windows ASIO drivers and FPGA core to achieve 32bit, low-jitter, bit-perfect signal path. It will play natively all formats up to DSD512, PCM and MQA up to 384 kHz.

We hope that the exaSound s82 Mark II will help you to enjoy world-class music experience for years to come. Please take the time to read right through this manual. Investing a little time now is the best way to ensure that you will make the most of your new streaming DAC and Roon Server.

Happy listening,

exaSound Audio Design

www.exaSound.com

CustomerService@exaSound.com

Package Contents

The following items should be in the box:

- exaSound s82 Mark II Streaming DAC
- IR remote control
- External universal power supply
- Two Wi-Fi Antennas (except for models without Wi-Fi support)
- Power cable
- USB Cable
- Ethernet Cable
- Quick Start Guide

Proper Device Placement

Place the device on a stable solid base, far from heat sources. Do not expose the device to direct sunlight. Allow at least 5 cm (2") around the device for ventilation. Do not place the device on fabrics, inside enclosed space, or in contact with curtains. **Do not place the device on top of power amplifiers or any other equipment that emits heat. Thermal damage is not covered by the warranty.** Do not expose the unit to smoke, humidity, moisture and water.

Overview

The exaSound s82 Mark II is a reference-quality stereo digital-to-analog converter streamer and server. Based on the ES9038PRO reference DAC chip, it delivers 32-bit precision capable of resolving the smallest signal details. The chip features patented 32-bit HyperStream technology. ES9038PRO delivers the industry's highest performance levels that will satisfy the most demanding audio enthusiasts.

s82 receives digital audio via Gigabit Ethernet, Wi-Fi 802.11ac, USB, built-in SSD and attached USB storage drives. It outputs analogue audio via balanced or unbalanced connection to your power amplifier or preamplifier. s82 Mark II also features a high-power headphone amplifier capable of driving the most demanding headphones.

s82 Mark II utilizes the exaSound's proprietary ZeroJitter™ asynchronous packet streaming technology, three-way GalvanicInfinity™ noise isolation and ZeroResolutionLoss™ hardware volume control architecture. Combined, these three technologies deliver dynamic and natural sound with vanishingly-low jitter, distortion and noise levels.

exaSound s82 Mark II supports most PCM music formats including FLAC, AIFF, WAV, as well as DSD formats including DSF and DFF. It offers ENclusiv™ High Resolution Audio (HRA) support - PCM sampling rates up to 384kHz at 32-bit resolution and DSD up to 24.576MHz (Octuple-rate / DSD512). S82 Mark II offers MQA full unfolding up to 384 KHz.

s82 Mark II features a build-in Roon Core. It will work with the built-in streaming DAC and It can also stream audio to other network players on you your home network.

The UPnP server built-in the s82 Mark II can handle multiple independent UPnP audio zones.

The exaSound s82 Mark II configuration is managed via a Web browser. Playback is controlled with Roon, JRiver and various apps for iPad, iPhone, Android devices, Mac and PC.

exaSound s82 Mark II is a multi-level device. It can be used in simple and most-advanced network configurations. It supports several network audio standards including Roon RAAT, Tidal Connect, OpenHome, UPnP, HQPlayer NAA, Bluetooth and AirPlay. Additional network audio protocols will be available with software updates.

Tidal, Qobuz and other streaming services are also available with Roon, Bubble UPnP, and with AirPlay.

s82 offers unique Web streaming support for YouTube, YouTube Music, Qobuz and TuneIn Radio. YouTube support includes the video experience.

With features like remote upgrades and remote support, the s82 Mark II is future-proof and backed by the exceptional exaSound customer service.

Features for Sonic Fidelity

Bitperfect Streaming

The exaSound s82 Mark II supports audio streaming technologies that provide bitperfect lossless streaming - Roon RAAT, Signalyst NAA and Open Home/UPnP.

Asynchronous mode eliminates jitter caused by the LAN and the USB interfaces

Asynchronous streaming over LAN and USB is a two-way communication method between a computer and an external DAC.

s82 Mark II controls the rate at which audio data is transmitted over USB. Rather than being sent as a continuous stream, as is the case with standard USB audio interfaces, the data is sent in packets. If a streaming error is detected, the faulty packet is retransmitted. Packet retransmission for error correction is possible because audio data is streamed at speed higher than the playback speed.

The incoming data is stored in a hardware buffer in the DAC module. The data is then clocked out of this buffer by the s82 high-precision master clock. Re-clocking guarantees a very high accuracy and precision of data timing. It completely eliminates jitter caused by computer timing errors, the USB and LAN data transports. An added bonus to using packet-based streaming over USB is the ability to send and receive control information along with the audio data. This is how volume control instructions are exchanged between the s82 DAC and player apps, computers and audio servers.

Windows ASIO Driver

Using ASIO brings unique advantages that are hard to achieve with other Windows driver technologies.

Automatic PCM / DSD / MQA Switching

Audio data is always streamed in its native format. s82 enters automatically native PCM, DSD or MQA modes. DSD streams are processed in their native format without conversion to PCM.

Bit-perfect operation independent from the Windows volume control and mixer

The Windows volume control and mixer are made to provide wide compatibility and easiness of use. Usability and convenience comes at the expense of sonic fidelity. The resulting output may not be bit-perfect or bit-transparent. Third-party proprietary Windows drivers are hard to be verified as bit-perfect because factors beyond the control of the user can change the Windows sound processing chain. The exaSound proprietary ASIO drivers provide bit-perfect operation independent from the Windows volume control and mixer.

Hardware Volume Control and Volume Bypass

The s82 DAC volume control is implemented by the ES9038PRO DAC chip. In USB mode it is completely independent from the Windows software volume controls. Audio data is always bit-streamed over the USB interface at full scale 0dB/32bit resolution. Volume processing is performed by the DAC chip right at the border between the digital and the analogue domains. This architecture offers signal to noise ratio

comparable to the best analogue volume controls. Setting the volume to 0dB turns all volume processing off and sets the s82 DAC in volume bypass mode.

ASIO Volume Control Integration with JRiver and Roon on Windows

The exaSound Volume Synchronization Plug-ins allows JRiver for Windows / JRemote and Roon to access the hardware volume control built in all exaSound DACs.

Roon Ready Network Player



The exaSound s82 is a Roon Tested DAC and Roon Ready network player. It has been profiled and tested by both Roon Labs and exaSound for maximum compatibility. Roon recognizes exaSound devices and sends them audio optimized for their capabilities. Together, Roon and exaSound deliver the power, flexibility, and performance benefits of digital audio, with the easiest setup and highest reliability available.

MQA (Master Quality Authenticated)



MQA is an award-winning British technology that delivers the sound of the original master recording. The master MQA file is fully authenticated and is small enough to stream or download.

The s82 Mark II includes MQA technology, which enables you to play back MQA audio files and streams, delivering the sound of the original master recording. Visit mqa.co.uk for more information.

MQA and the Sound Wave Device are registered trade marks of MQA Limited. © 2016

Front and Rear Panels

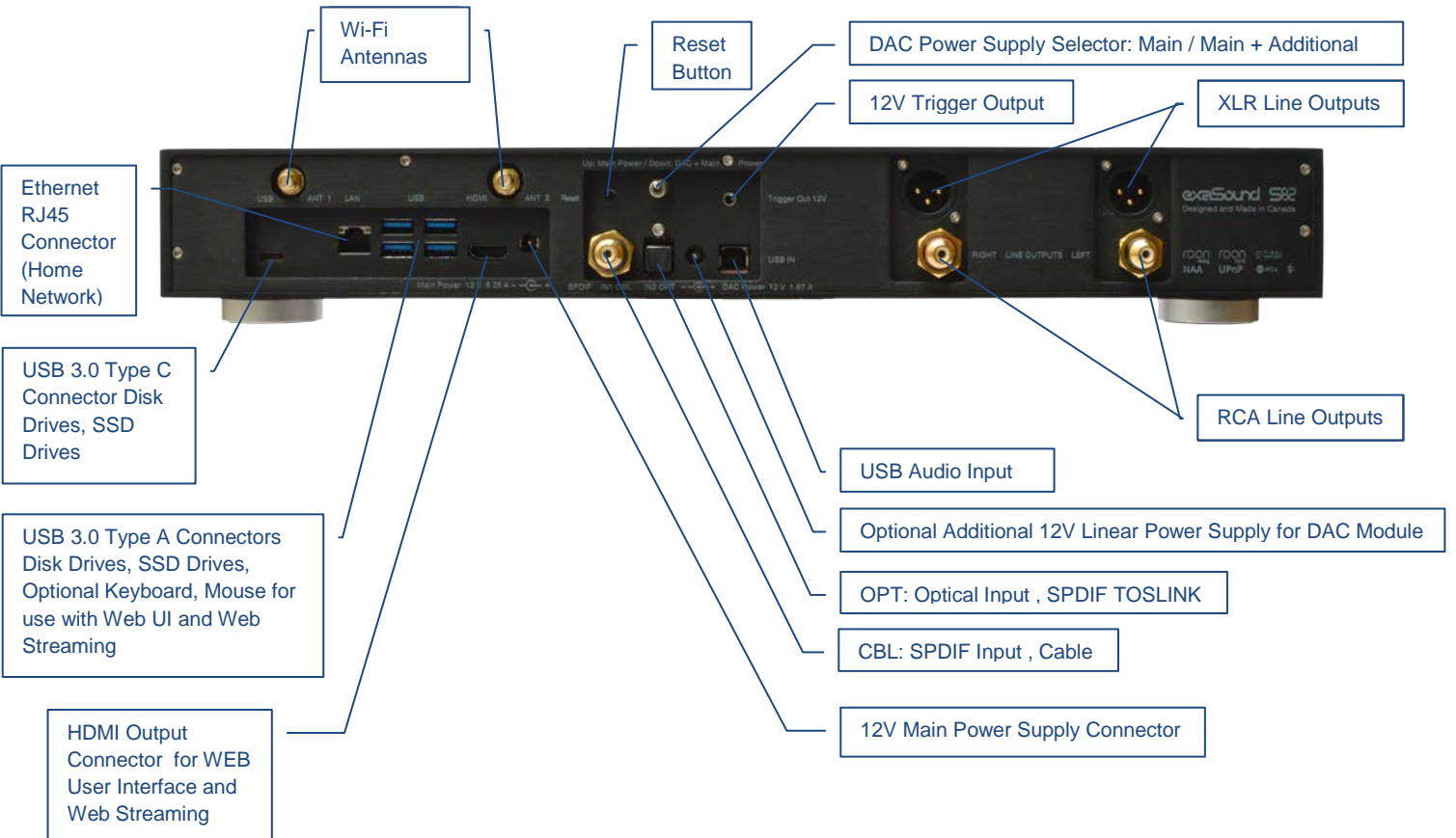
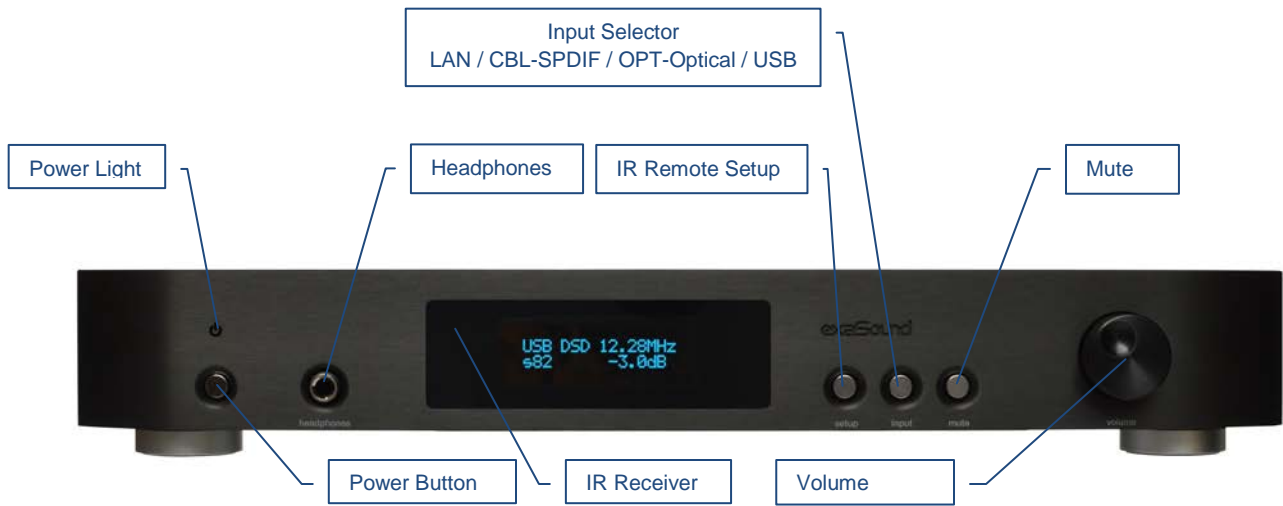

Infrared Remote Control

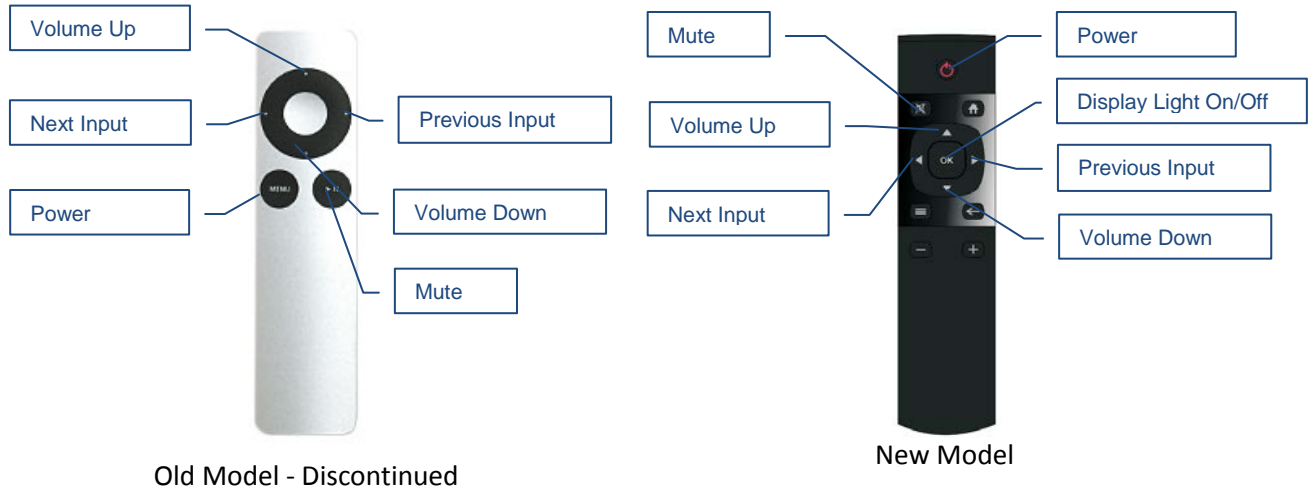

Your s82 Mark II is pre-programmed to work with the supplied remote control. It can also be re-programmed to work with most infrared remote controls using Sony and NEC IR protocols, for example the Sony RM-EZ4 Universal Remote.

See the **Remote Control Setup** section for instructions on how to change button assignments and how to pair a different remote control with your s82.

Connecting the s82 Mark II Streaming DAC and Roon Server



Before connecting, turn off the power to all components in your system.

Connecting the Digital Inputs

All digital inputs are galvanically isolated to eliminate ground loop noise. The s82 Mark II accepts four digital audio inputs:

- **LAN** - Ethernet connection to home router or switch for streaming digital audio. Supports PCM up to 32 bit resolution at standard sampling frequencies from 44.1 kHz to 384 kHz and DSD up to 12.288 MHz/DSD512.
- **IN1 CBL** - SPDIF Input, Coaxial Cable 75-ohm RCA. Supports PCM up to 24 bit resolution at standard sampling frequencies from 44.1 kHz to 192 kHz.
- **IN2 OPT** - Optical Input, SPDIF TOSLINK. Supports PCM up to 24 bit resolution at standard sampling frequencies from 44.1 kHz to 96 kHz.
- **USB** - USB Audio Input for connecting a Windows computer for music playback with ASIO compatible player apps like JRiver and Roon. Supports PCM up to 32 bit resolution at standard sampling frequencies from 44.1 kHz to 384 kHz and DSD up to 24.576 MHz/DSD512.

Inputs / Outputs for USB Peripherals:

- **USB 3.0** Connectors - support spinning disks and SSD drives for music storage.
- **USB 2.0** Connectors - support spinning disks and SSD drives for music storage, optional keyboard and mouse for use with Web UI, optional USB display.

Connecting the Line Outputs

s82 Mark II offers two types of analogue line outputs - unbalanced (RCA) and balanced (XLR).

- Before making a connection make sure that your audio amplifiers are powered down.
- **RCA Line Outputs** - Connect the RCA line outputs of the s82 Mark II to the amplifier line inputs.
or
- **XLR Line Outputs** - Connect the XLR line outputs of the s82 Mark II to the amplifier line inputs.

You can use simultaneously the XLR and RCA outputs without output signal degradation since they are powered by autonomous output stages.

Connecting TV, USB keyboard and Mouse (Optional)

Web Streaming requires HDMI TV or monitor, USB keyboard and Mouse to be connected to the s82 Mark II.

- Connect HDMI TV or monitor to the HDMI Output Connector.
- Connect a wireless USB receiver for Mouse and keyboard to a USB 2.0 connector.

Trigger Output

When the s82 Mark II is on, a 12 VDC signal is present on the trigger output to control other devices. When the s82 Mark II is placed in standby mode or power saving mode, the trigger signal is discontinued.

Direct Connection to Analogue Power Amplifier

If all your music sources are digital, you don't need a preamplifier. The built-in volume control allows analogue power amplifiers to be connected directly to the s82 Mark II. Amplification always brings some level of noise and distortion. Eliminating unnecessary pre-amplification helps to achieve higher level of sound transparency.

	<p>Avoid connecting the s82 Mark II to receivers or any other sound processing equipment that performs analogue to digital (ADC) conversion. Digitizing the analogue output signals back to the digital domain will undo some of the benefits that s82 Mark II brings to you. Remember that your sound system is as good as the weakest link in the sound processing chain.</p>
---	---

Power Supply

The s82 Mark II supports two power supply configurations.

Single Power Supply Configuration

- Make sure that the Power Supply Selector toggle switch is in the Up position.
- Connect the provided universal 12V/6.25A power supply to the 12V Main Power Supply socket on the back plate.
- Plug the power supply to the mains.
- The s82 Mark II display will illuminate and show the model number and revision for about 3 seconds.
- The s82 Mark II will enter stand-by mode.

Connecting Additional Linear Power Supply for the DAC Analogue Stages

To achieve the lowest possible noise level, a third-party linear power supply can be used for the DAC analogue circuits and IV stages.

- Make sure the s82 is powered off (The power light must be off).
- Put the Power Supply Selector toggle switch is in the Down position.
- Connect the provided universal 12V/6.25A power supply to the 12V Main Power Supply socket on the back plate.
- Connect the third-party 12V linear power supply to the DAC Power socket.
- Plug the power supplies to the mains.
- The s82 display will illuminate and show the model number and revision for about 3 seconds.

- The s82 will enter stand-by mode.

	<p>Don't switch the Power Supply Selector when the s82 is turned on. This may cause the s82 to shut down. Power on/off transients can be transmitted to the loudspeakers.</p>
---	---

To minimize ground noise and hum, it is recommended to connect the power cords of all components to a single point - usually a single surge protector with multiple outlets. Connecting all components to a single point, as close as it is practically possible minimizes the differences in ground potentials between the components.

	<p>Using Third-Party Power Supplies s82 Mark II comes with a universal power supply that has been tested to comply with the s82 Mark II's quality requirements and allows for very high performance.</p> <p>If you use third-party power supplies, the specifications marked on the back of the s82 Mark II power sockets must be observed.</p>
---	--

Surge Protectors

We strongly recommend the use of surge protectors for all of your audio and video components.

Isolating the Cable TV Ground

If you have a cable TV connected to your audio system, ensure that the TV cable ground is galvanically isolated from the audio system ground. The TV cable ground, usually connected to the earth outside your home, can have a significantly different potential than the audio equipment ground. This condition can cause audible hum. If you suspect this is the case, use a cable TV ground isolator just before the cable set-top box or at the RF TV input.

	<p>When turning on and off your sound system, the power amplifier should be the last component to be turned on and the first component to be turned off. This prevents power on/off transients from being transmitted to the loudspeakers.</p>
---	--

How to Use the s82 Mark II streaming DAC and Roon Server

Roon Ready Network Player

Roon offers an engaging, enjoyable way to browse your music. Via intelligent automatic cloud service library management, Roon delivers metadata for the user's library and frees the user from the complexities of library management.



s82 Mark II is certified as a Roon Tested DAC and Roon Ready network player. Roon Ready is the highest level of Roon integration and means that Roon technology is customized and embedded for achieving the best user experience.

Playback is controlled with the Roon Remote app. Here is how it works:

- Roon is a subscription service. You can find out more about the trial period and about subscription plans on the Roon website - [RoonLabs.com](https://www.roonlabs.com).
- You need to connect the s82 Mark II to your home router with Ethernet cable or with Wi-Fi.
- The Roon playback engine - Roon Core - is pre-installed on the s82 Mark II. The Roon Core can also be installed on any other Roon server like the exaSound Delta Server or any third-party music server. Alternatively, the Roon Core can be installed on Mac or Windows computer. Your Roon server must be connected to your home network and to have access to the Internet.
- Your music files can be stored on the s82 Mark II internal SSD storage, attached USB drives, on your stand-alone Roon server or on Network Attached Storage (NAS).
- Playback is controlled by the Roon Remote App available for Apple iPhones, iPads and Android devices. You need to install it on your device from the Apple App Store or from Google Play. Playback can also be controlled from PC or Mac.
- Roon connects to the Roon Service to retrieve rich and well organized information about your music files.
- Roon provides access to the Tidal and Qobuz online streaming services.
- The Roon Remote app can transparently discover and connect to the s82 Mark II.

You can find more information about Roon here: [How Roon works](#). Questions about Roon can be posted on the [Roon Community](#) forum.

Tidal Connect Player



Tidal Connect support allows the Tidal native apps on iOS, Android, Mac OS and Windows to stream directly to the S82. Visit the Tidal website for more information [How to use Tidal Connect](#).

USB ASIO DAC

The s82 can be connected to a PC via USB cable and used with players like JRiver, Roon, HQPlayer and Audirvana. ASIO-compatible player is required on the Windows platform. You will need to install our proprietary drivers. Step by step instructions are available in this guide and on exasound.com/Blog.aspx.

UPnP /OpenHome Player and Audio Library Server

The s82 Mark II supports the public UPnP/OpenHome audio streaming standards. It can be used as a player (also called renderer or audio endpoint).

s82 Mark II offers built-in UPnP audio library server. Music files for the UPnP library can be stored on the internal SSD storage and on USB drives connected to the s82 Mark II. Playback can be controlled remotely with apps from an iPad, iPhone, Android device, PC or Mac. Popular control apps for Android include Bubble UPnP and Kazoo. Mconnect Player HD, Kazoo and others are available for iPad and iPhone.

Third-party UPnP library servers including MinimServer, Asset UPnP and Twonky can be used with the s82 Mark II. There are many other third-party UPnP/OpenHome control apps and library servers. The ones listed here are tested with the s82 Mark II and support all high-resolution formats and sampling rates up to DSD512. Step-by-step guides for configuring the exaSound streaming devices for use with UPnP/OpenHome are available on exasound.com/Blog.aspx.

Network Audio Adapter for HQPlayer

The exaSound s82 Mark II supports Network Audio Adapter (NAA) protocol for network audio streaming with HQPlayer. The [Signalyst HQPlayer](https://signalyst.com/) offers advanced upsampling and PCM to DSD conversion algorithms. Follow the Step-by-step guide for configuring the exaSound s82 for use with *HQPlayer* available on exasound.com/Blog.aspx.

AirPlay Player

AirPlay is a popular and convenient network media streaming technology. AirPlay can be used to stream content from online services to the s82 Mark II.

AirPlay support is implemented with Shairport, an open-source emulator for Airplay. Since this is not an official Airplay implementation, reliability may vary. Note that the AirPlay protocol has some limitations compared to the other network streaming technologies used by the s82 Mark II. It supports CD-quality audio. DSD and high-sampling rate/high-resolution PCM formats are down-sampled.

Bluetooth Music Player

s82 supports Bluetooth audio streaming.

Bluetooth does not support natively DSD and high-sampling rate/high-resolution PCM formats.

Web Streaming Player

Firmware update 49 introduces Web streaming support for YouTube, YouTube Music, Qobuz and TuneIn Radio. YouTube support includes the video experience. Web Streaming requires a TV or HDMI monitor, USB keyboard and mouse to be connected to the exaSound s82 Mark II.

Playing Music from Stereo SPDIF Sources

The s82 Mark II makes it possible to enjoy greatly improved level of sonic clarity and fidelity from SPDIF sources. The sonic improvement is the result of the outstanding jitter cancelling capability, superb signal to noise ratio, and low distortion levels of the s82 Mark II. You can connect up to two SPDIF devices, such as disk players and wireless music servers.



The s82 becomes unavailable for streaming on the home network when the **USB**, **CBL** or **OPT** inputs are selected. Roon, Tidal Connect, UPnP, Airplay, HQplayer and Bluetooth players won't be able to find the s82 until the **LAN** input is selected.

Quick Start Guide

Proper Device Placement

Place the device on a stable solid base, far from heat sources. Do not expose the device to direct sunlight. Allow at least 5 cm (2") around the device for ventilation. Do not place the device on fabrics, inside enclosed space, or in contact with curtains. **Do not place the device on top of power amplifiers or any other equipment that emits heat. Thermal damage is not covered by the warranty.** Do not expose the unit to smoke, humidity, moisture and water.

Initial Start-up

1. Make sure that the Power Supply Selector switch is in Up position.
2. Connect the exaSound universal power supply to the mains and to the Main Power socket of the s82 Mark II.
3. The s82 display will show the model number and revision for about 3 seconds. Then the s82 will enter stand-by mode.
4. Connect the s82 Mark II to your Gigabit home network with Ethernet CAT 6 cable.
5. Connect the outputs of the s82 Mark II to your preamp or power amp. Don't turn them on yet.
6. Press the s82 Mark II power button, the power light will come on.
7. In about 30-40 seconds the display will illuminate and the s82 will be available on the home network for use with apps like Roon Remote, Tidal Connect, HQPlayer, Mconnect Player HD, Bubble UPnP, Hi-Fi Cast, Kazoo and with AirPlay and Bluetooth streams.
8. For most applications the s82 streaming is ready to be used right out of the box. Manual configuration options are available via a Web User Interface.
9. To access the s82 Mark II web user interface start a web browser. In the address bar enter s82.local
10. Web user interface controls and settings are available when **LAN**, **CBL** or **OPT** input is active. When the **USB** Input is selected, the volume control sliders and other settings on the Web user interface become unavailable. These settings must be controlled with the exaSound Windows Dashboard.

Configuring a Wi-Fi Connection to the Home Network (Optional)

1. Attach the Wi-Fi antennas.
2. There are two ways to access the Web User Interface for configuring the Wi-Fi connection:
 - a) Use a temporary LAN cable connection to connect the s82 Mark II to your home network router or switch. Open a web browser and navigate to s82.local
 - b) Connect an HDMI monitor to the HDMI output connector, connect keyboard and mouse to the s82.
3. You will see the s82 Web User Interface.
4. From the menu on the Web page select **Network**.
5. Tap the Refresh button to see a list of available Wi-Fi networks.
6. In the list of Wi-Fi Networks, tap one of the double-arrow buttons on the right to select a network.
7. Enter the Wi-Fi password and tap the **Connect** button.
8. At this time the LAN cable connection is no longer needed.

Using the exaSound s82 Mark II with Roon

1. Select the **LAN** input of the s82 DAC.
2. Use a Web browser and navigate to s82.local to open the s82 Mark II Web User Interface.
3. From the **Settings Menu** select **Network Settings**.
4. Set the network password for coping files to the s82 storage drives. The username for s82 network share access is **playpoint**.
5. Copy your music files to the s82 over the home network.
6. Open the Roon Remote app and connect it to the Roon Core on the s82. You will need to enter your Roon username and password. You can also connect to other Roon servers on your home network.
7. The s82 internal SSD drives are preconfigured for use with Roon.
8. If you are using a USB drive with music files connected to the s82, you need to configure it in the **Storage Settings** window of the Roon Remote app.
9. From the Roon Remote app menu select **Settings**.
10. From the list on the left select Audio.
11. Select exaSound s82 from the list of Roon Ready devices.

Note: Don't use the s82 AirPlay connection.

Using the exaSound s82 Mark II with Tidal Connect

1. Select the **LAN** input of the s82 DAC.
2. Visit the Tidal website for instructions [How to use Tidal Connect](#) on your device.

Using the exaSound s82 Mark II with UPnP

1. Select the **LAN** input of the s82 DAC.
2. Use a Web browser and navigate to s82.local to open the s82 Mark II Web User Interface.
3. From the **Settings Menu** select **Network Settings**.
4. Set the password for coping files over the home network to the s82 storage drives. The username for s82 network share access is **playpoint**.
5. Copy your music files to the s82 over the home network.
6. You can also connect a USB drive with music to the s82 Mark II.
7. From the **Settings Menu** of the s82 Mark II Web User Interface select **General Settings**.
8. On the UPnP music Library tab tap on the **Update** button. Library update can take a while.
9. Use an UPnP app like Mconnect Player HD or Bubble UPnP.
10. Configure your UPnP app for use with streaming services like Tidal and Qobuz.
11. Configure your UPnP app to use the s82 Mark II as playback endpoint, or audio zone. It will appear in the list of available players as **s82**.
12. Configure your UPnP app to use the s82 Mark II as music library. It will appear in the list of available music libraries as **s82 Library**.

Using the exaSound s82 Mark II with HQPlayer

The exaSound s82 Mark II supports Network Audio Adapter (NAA) protocol for advanced upsampling and PCM to DSD conversion applications with the Signalyst HQPlayer. Make sure the s82 **LAN** input is

selected. Follow the Step-by-step guide for configuring the exaSound s82 for use with HQPlayer available on our blog - exasound.com/Blog.aspx.

Using the exaSound s82 Mark II with AirPlay

3. Select the **LAN** input of the s82 DAC.
4. Start music playback. Pull down from the top edge of the iPad screen.
5. Tap the Airplay icon in the upper right corner of the audio player box.
6. A list of Airplay compatible devices will appear.
7. Select **s82**. You will see a checkmark next to it.

Windows ASIO Driver Setup

1. The ASIO driver is required only if you use USB connection to a Windows computer with music player apps like JRiver, Roon and HQPlayer.
2. Use the username / password that we've emailed you with the shipping confirmation email to login to support.exasound.com.
3. Download and unzip the latest **exaSound Windows ASIO Driver**.
4. Run *exaSound-N1-5-3-54-Setup.exe (or later version)* and follow the prompts. ASIO driver step-by-step setup instructions are available in this guide.
5. Reboot your computer.
6. Setup your ASIO compatible player (Roon, JRiver Media Center, HQPlayer etc.) to use the exaSound ASIO driver. Check the **Guides** section of the exaSound blog for step-by-step player configuration instructions: exasound.com/Blog.aspx.
7. Select the **USB** Input of the s82 DAC. The exaSound Dashboard will detect the USB connection.
8. Click on the *exaSound Dashboard* icon next to the clock on the Windows System Tray and set the master volume.

exaSound Dashboard (Windows)

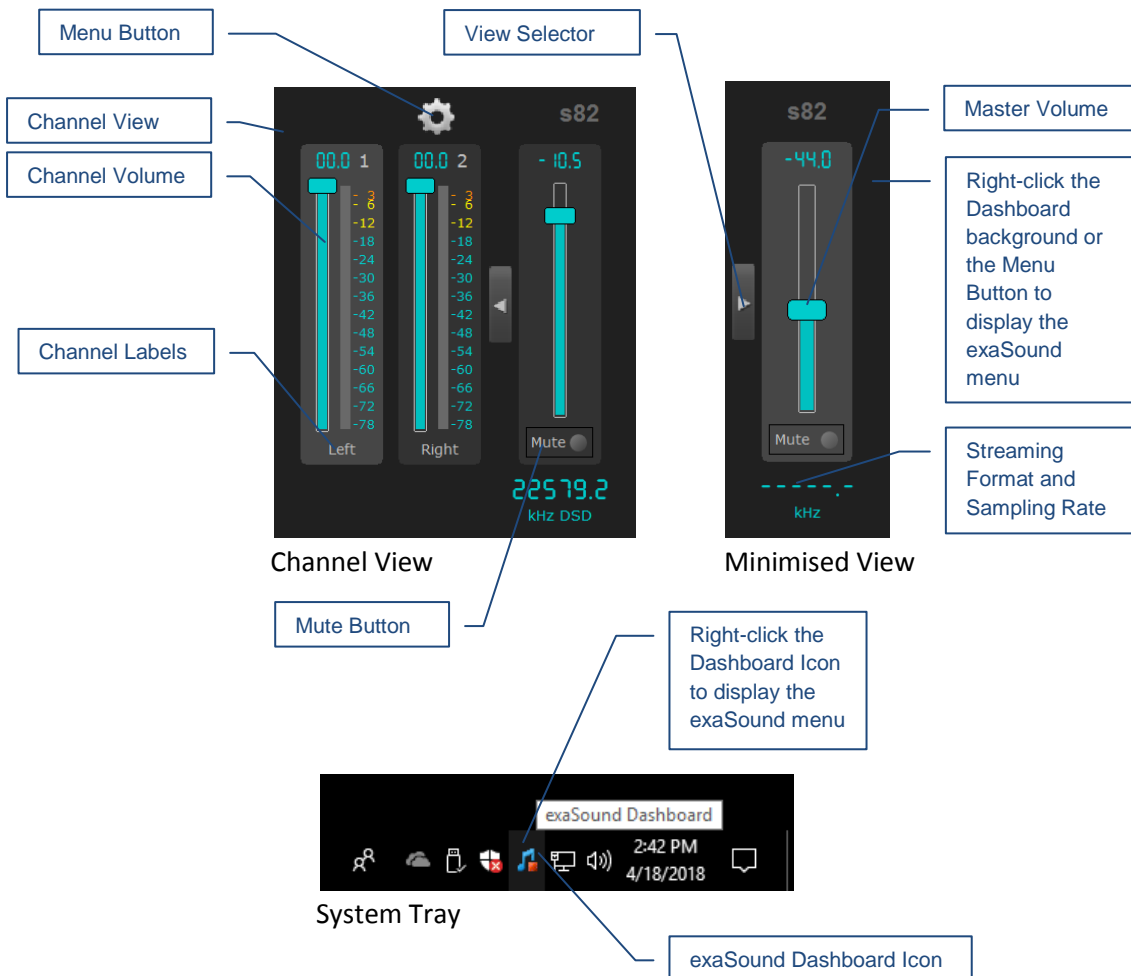

s82 Mark II Configuration

For most users the s82 Mark II doesn't require any manual setup. Custom network configuration and other settings are available via a web page hosted on the s82 Mark II. To access it, make sure that the **LAN**, **CBL** or **OPT** input is selected. Open a web browser and in the navigation bar enter s82.local.

	Some controls on the Web User Interface are unavailable when the USB Input is selected. Use the Windows Dashboard to configure and control the s82 functionality related to the use of the USB input.
---	--

	Some controls on the Web User Interface are unavailable when s82 enters power-saving mode. Press anyone of the three buttons on the right side of the s82 front plate to resume operation.
---	--

Computers running Windows 10 or later, Mac computers, mobile phones and tablets will discover automatically your exaSound s82 Mark II on the home network. If your Windows computer is running an older version of Windows or if it is unable to find the s82 Mark II on the home network, you will need to install [Apple Bonjour](#) or compatible zero-configuration networking (zeroconf) service. On Linux computers you need to install [Avahi](#).

If you change the name of the s82 the web address will change. For example if you call it **s82-zone1**, the web address will be **http://s82-zone1.local**

Alternatively, you can access the settings configuration pages by connecting a keyboard, mouse and HDMI monitor to the s82 Mark II. This is useful when you don't have access the s82 Mark II over the network.

When you connect to the s82 Mark II with a Web browser you will see the **Home Page**. You will see the **Main Menu**, a row of graphical buttons along the top edge of the page. From the **Main Menu** you can access various pages that control playback, provide information about the current track, general information about the device, configuration settings and support functions.

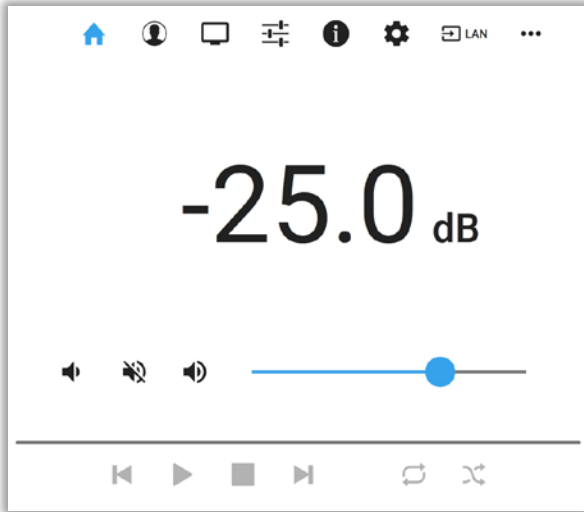

Home Page

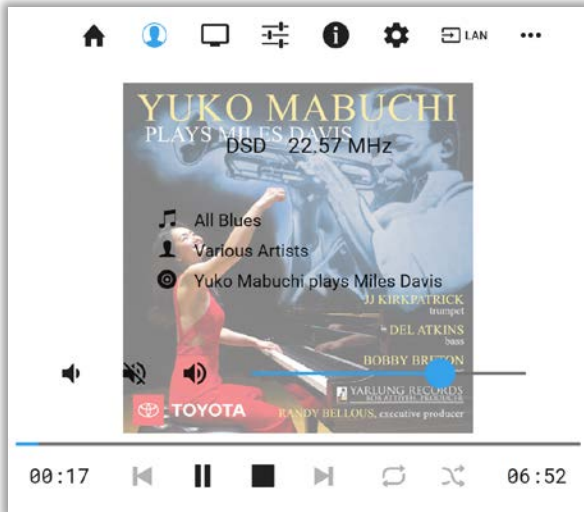

Metadata Page

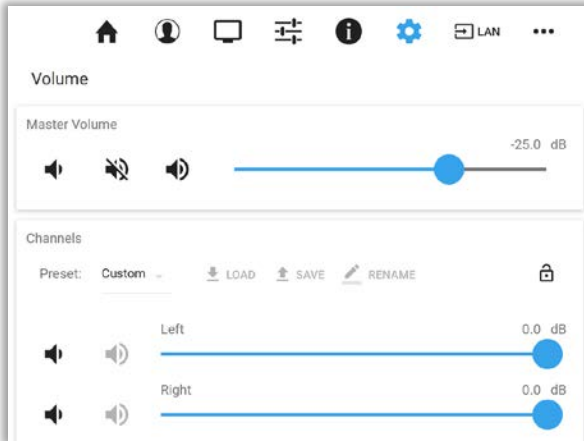

Volume Control Page

Input Selection

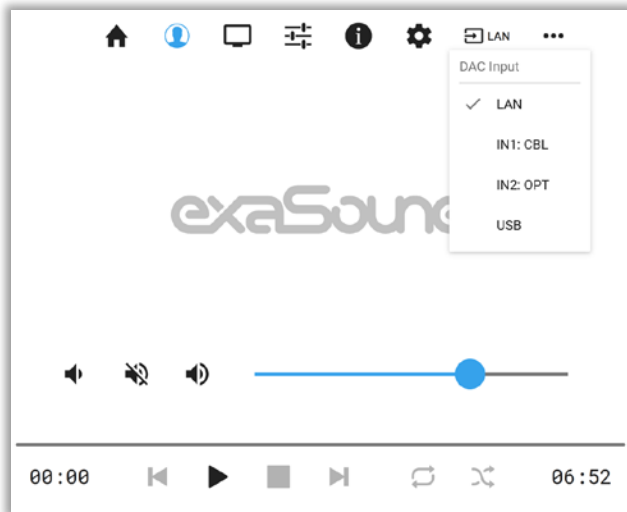

Input Selection Menu

Inputs can be selected in several ways:

- From the Input Select button on the s82 front plate.
- From the Input Select button on the IR remote control.
- With the Audio Input buttons on the Web and Windows Dashboards

Note: When the **USB** input is active, the **CBL** and **OPT** inputs are not available. First select the LAN input and then click **CBL** or **OPT**.

Device Information

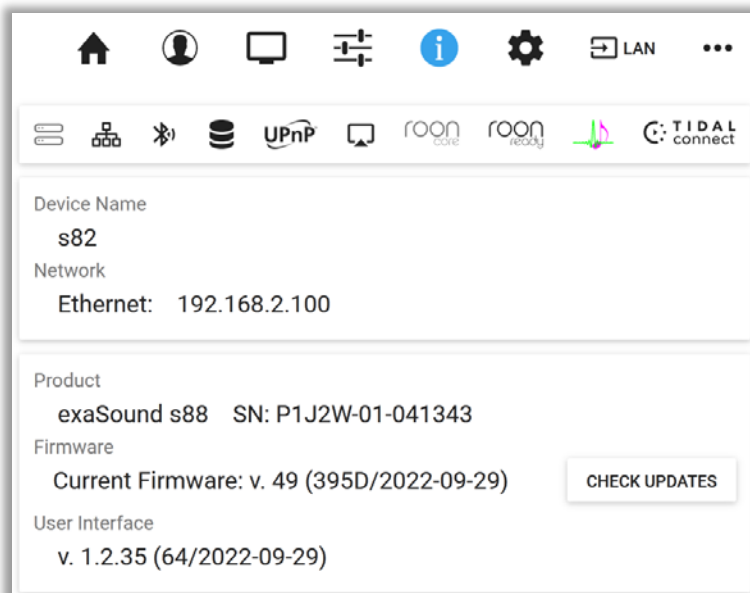

Device Information Page

Tap or click on the second row of icons to display the current status of various services. On this page you will find information about the **Device Name (Host Name)** and IP address used to access your s82 Mark II over the home network. The **Host Name** and the network configuration can be configured on the **Network Settings Page**.

Firmware Updates

Use the Device Information page to find the current firmware version and to check for firmware updates.

Performing Firmware Updates

1. Disconnect any USB storage drives from the s82 Mark II. External USB storage devices may interfere with the update.
2. Make sure that the s82 Mark II power supply is reliably connected.
3. Make sure the s82 Mark II is connected to your home network and your Internet connection is stable.
4. Go to the Product Tab and tap the **Check for Updates** button.
5. If a new firmware version is available, Tap **Update**.
6. You will see a progress indicator. Don't interrupt the power to the s82 Mark II during the update or your device may become unstable.

Settings Menu

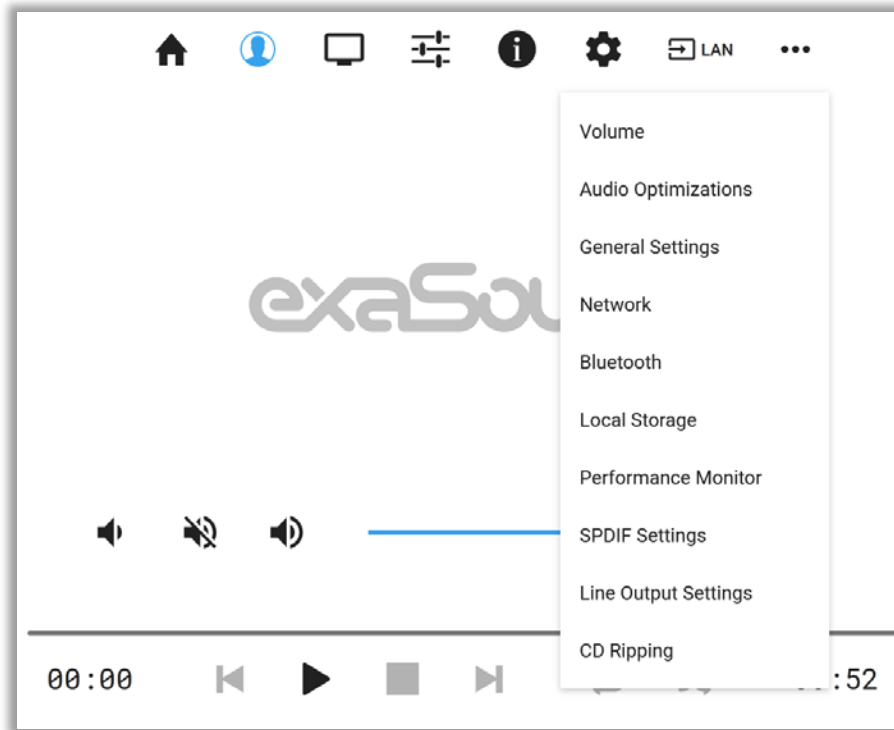

The gear button on the **Main Menu** opens the **Settings Menu**. This is the entry point for all configuration pages for your s82 Mark II.

Wi-Fi Configuration

1. Navigate a web browser to the s82 Mark II Web User Interface. By default the address is s82.local
Tap or click the gear icon on the **Main Menu** and select the **Network Settings** page.
2. Scroll down to the **Available Wi-Fi Networks** tab and tap the **Refresh** button.
3. You will see a list of available Wi-Fi networks.

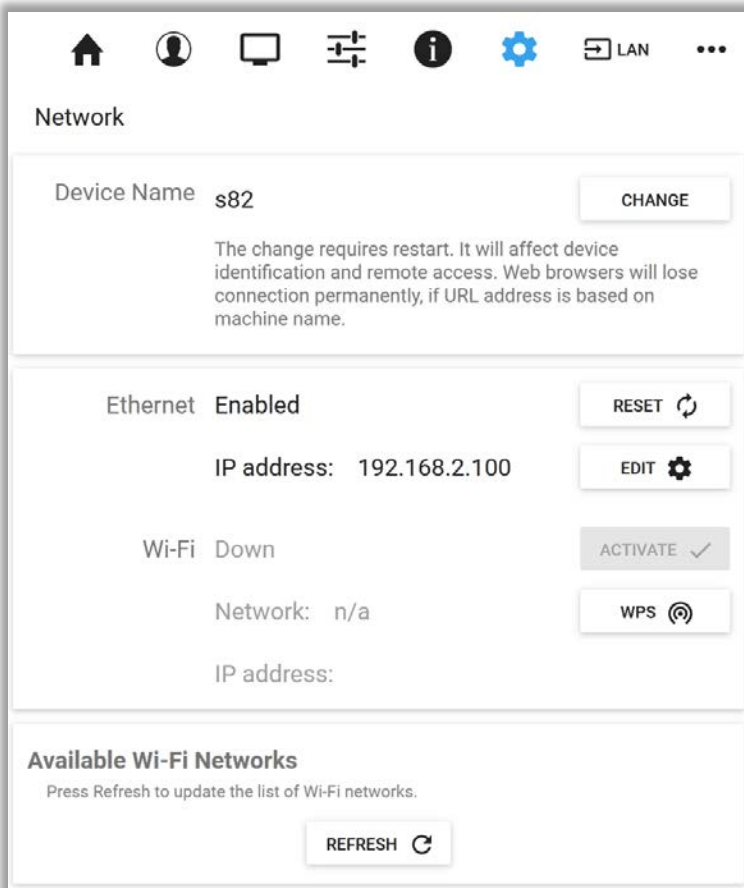

4. Locate the Wi-Fi network that you need to connect to and tap on the  icon to the right.
5. Enter the password if you are connecting to a secured network. The s82 Mark II supports **WPA2-PSK (AES)** security mode.
6. At this point if you are using an **Automatic IP** (DHCP).



Use the buttons on the right to manage advanced network configurations, like setting up a static IP address. It takes a moment for the new setting to be applied and the system will display a waiting prompt.



When the Network page reappears you should see the new IP address.

Note that only one network connection can be enabled at any time. You can use either the Ethernet wired connection or the Wi-Fi connection.

We recommend using wired connections because they are more reliable and easier to setup and maintain.

	<p>Note that if you use an IP address to connect your Web browser to the s82 Mark II, the browser won't be able to reconnect automatically. In this case you will need to manually enter the new IP address for the s82 Mark II in the navigation bar of the Web browser.</p>
	<p>If you enter incorrect network settings you may be unable to connect to the s82 Mark II over the network. In this case you can use an alternative method to access the web user interface:</p> <ul style="list-style-type: none"> • Connect a USB keyboard and mouse. • Connect HDMI display to the HDMI output • Use the Network page to correct the network settings or to restore the automatic (DHCP) network configuration.
	<p>Network settings can be reset to factory default by pressing and holding for 5 seconds the Reset button on the back plate of the s82. Use the tip of a pen or similar object to press and hold the button. The s82 will reboot. The LAN input will be activated in DHCP mode (Automatic IP assignment).</p>

Multi-room Configuration and Using a Custom Device Name

Each s82 Mark II on your home network must have a unique name. Use the **Network Settings Page** to assign a custom device name (host name) to your s82 Mark II.

1. Tap or click on the gear button on the **Main Menu** to open the **Settings Menu. Select Network.** The current host name will be displayed on the **Device Name** tab.
2. Tap on the Change button and enter a new host name.
3. The s82 Mark II will shut-down and restart.
4. Remote control apps must be reconfigured to use the new s82 Mark II host name.

Example: if you change the device name to **zone1**, you will need to enter **zone1.local** in the navigation bar of your Web browser to access the s82 Mark II web user interface.

To access the shared drives from Windows Explorer or Mac Finder you will need to enter **\\zone1** or **smb://zone1 /USB**

Ethernet Connection with Manual IP Address

Navigate your web browser to the s82 Mark II Web Interface. Open the menu and select the **Network** page.

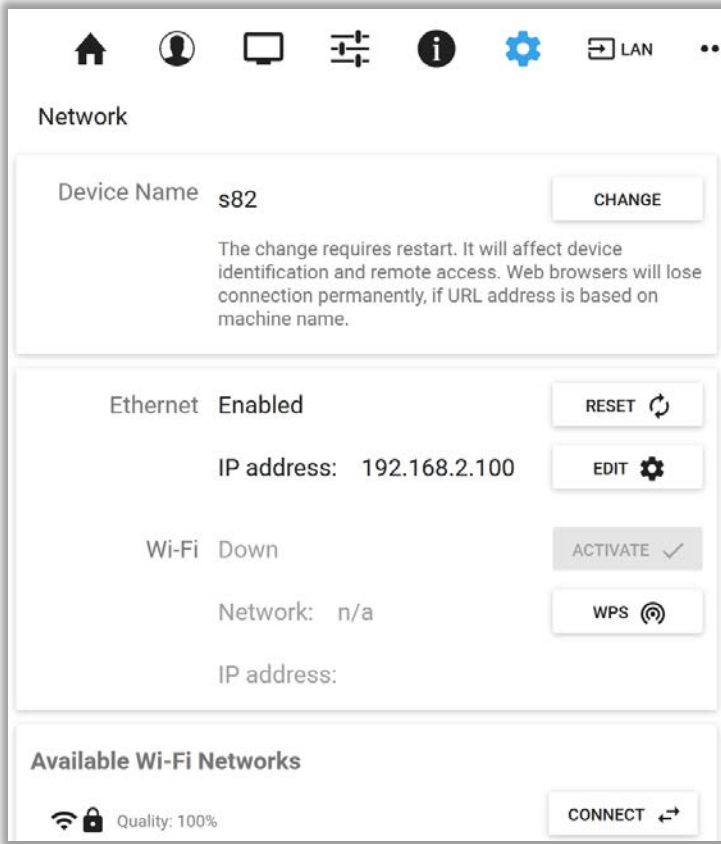

By default the s82 Mark II will use the wired network connection - Ethernet.

You can use the **Reset** button to re-initialize the network connection. This is useful when the settings on your router are changed or in case the connection is lost.

1. Locate the **Ethernet** tab and tap on the **Edit** button.
2. Select **Manual IP**. Enter proper IP address, subnet mask and gateway. Press apply when you are ready.

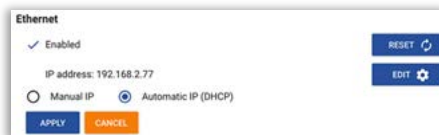



3. It will take a moment for the new settings to be activated. You will see a **Waiting for Connection** message.



Waiting for connection...

4. When the Network page reappears you should see the new IP address.

	<p>Note that if you use an IP address to connect your Web browser to the s82 Mark II, the browser won't be able to reconnect automatically. In this case you will need to manually enter the new IP address for the s82 Mark II in the navigation bar of the Web browser.</p>
	<p>If you enter incorrect network settings you may be unable to connect to the s82 Mark II over the network. In this case you can use an alternative method to access the web user interface:</p> <ul style="list-style-type: none">• Connect a USB keyboard and mouse.• Connect HDMI display to the HDMI output <p>Use the Network page to correct the network settings or to restore the automatic (DHCP) network configuration.</p>

Switching Between Wireless and Wired Network Connection

Only one network connection can be active at any time. Use the **Activate** buttons to switch between wired and wireless network connection. Player apps may have to be restarted after changing the network connection.

Resetting the Network Connection to Factory Defaults

In case you are unable to connect to the exaSound s82 Mark II over the home network you can reset the networking settings to the factory defaults:

1. Locate the Reset button on the back plate.
2. Use a ball pen or similar object to press and hold it for about 5 seconds.
3. The s82 DAC will restart.
4. The wired Ethernet connection will be enabled in DHCP mode.

Sharing Connected USB Drives on the Network

File Sharing allows you to have access via the home network to the s82 internal SSD storage and connected USB drives. You can use file management apps like Windows Explorer and the Mac Finder to copy, move and erase files stored on the s82 Mark II.

- Use the **File Sharing** tab on the **Local Storage** page to enable or disable file sharing and to set the password for accessing the storage shares.
- The username is **playpoint**

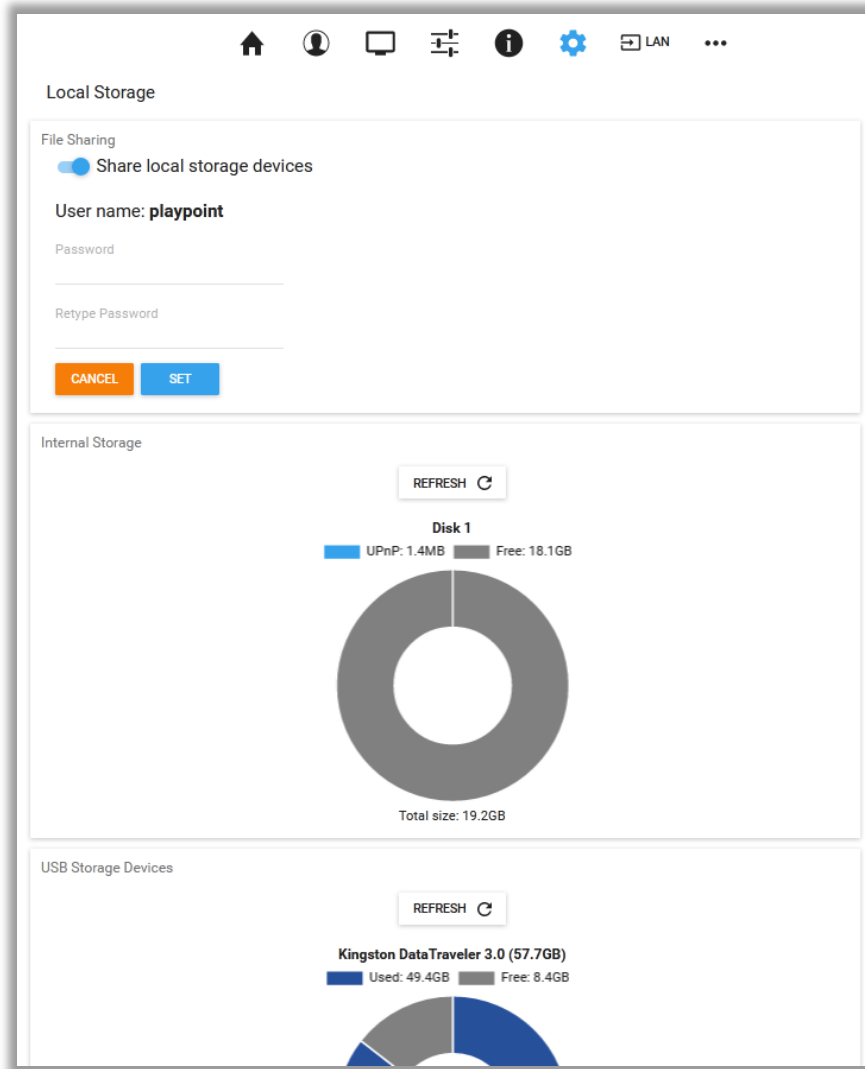





The Internal Storage tab displays information about the size of the music libraries stored on the s82 Mark II internal SSD drive.

	Make sure that there always is at least 20% free space on the s82 Mark II internal SSD drive.
---	---

The **USB Storage Devices** tab on the **Local Storage** page displays list of connected USB drives.

To safely disconnect an USB drive from the s82 Mark II:

- Close any applications on remote computers that may be using files on the s82 Mark II shared drives.
- Tap the Eject icon  to the right of the USB drive that you want to disconnect.
- If the USB drive is in use, an error message will be displayed at the lower edge of the screen.
- If you are unable to eject the drive and continue to get error messages, power off the s82 Mark II and then disconnect the USB drive.

	Always maintain a backup copy of your music files.
	Never disconnect a USB drive during playback.
	To avoid accidental data loss we recommend powering down the exaSound s82 Streaming DAC before disconnecting USB drives.

General Settings Page

Use the Settings tab on the web user interface to configure the s82 Mark II.

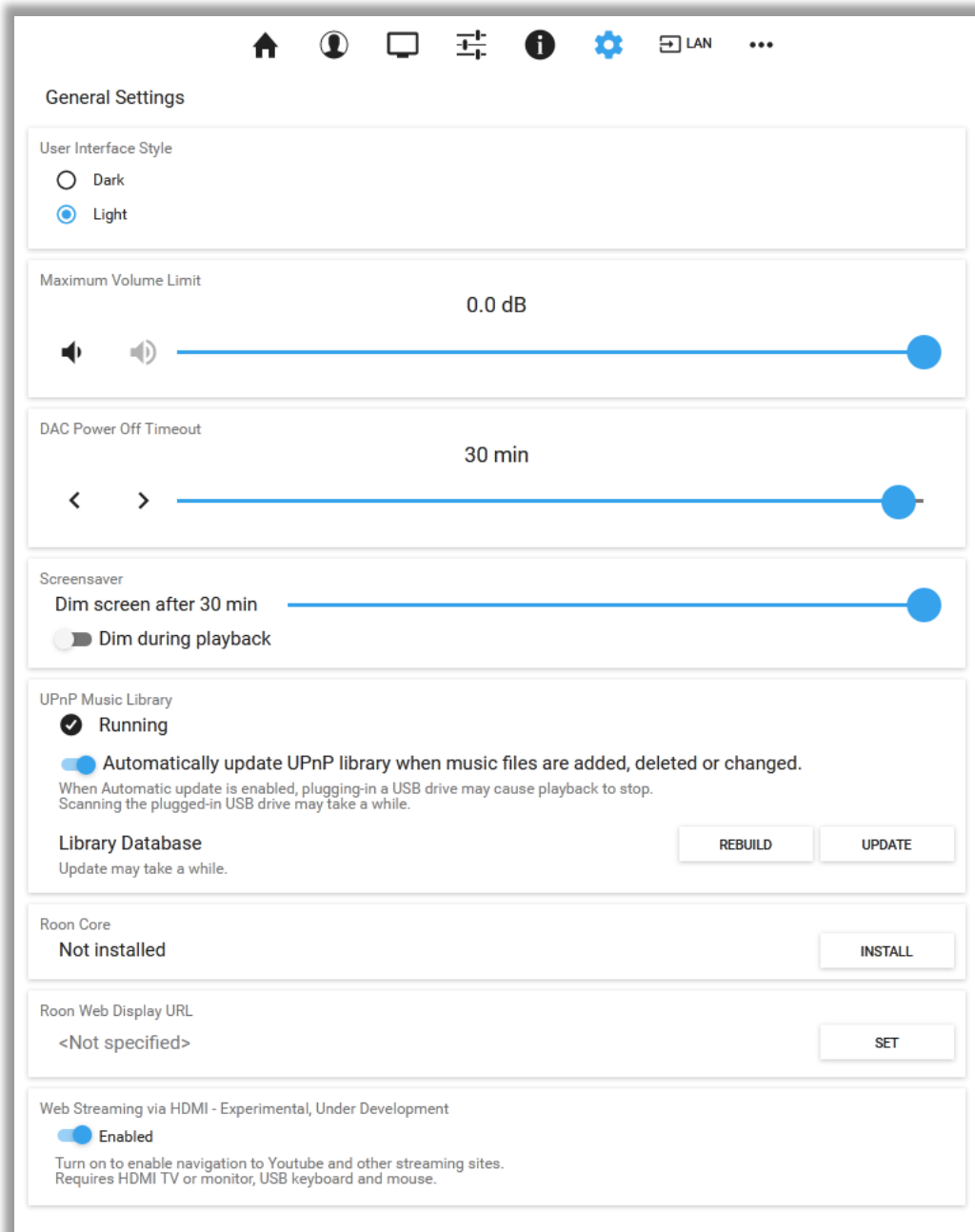

The following features will appear:

- User Interface Style
- Maximum Volume Limit
- DAC Power off Timeout

- Screensaver Timeout
- UPnP Music Library Settings
- Roon Core Installation
- Roon Web Display URL (see [Roon Display Help](#) on the Roon website)
- Web Streaming via HDMI (experimental feature)

Power Saving Mode Timeout

The s82 Mark II can enter power-saving mode after a period of inactivity. You can use the **DAC Power Off Timeout** tab to set the time-out period.

The power savings slider is located on the **General Settings** page. Moving the slider to the rightmost position disables the DAC automatic power saving feature.

During power saving mode, the power LED will be on and the screen will be dark. Some features on the Web user interface become unavailable when the s82 is in power-saving mode.

Use one of the following actions to exit power saving mode and to resume normal operation:

- Press the Setup, Input Select or Mute buttons on the front panel or on the IR remote control.
- Turn the volume knob or press the volume up or down buttons on the IR remote control.
- Start music playback on the LAN or USB inputs.

Advanced Settings - Audio Optimisations

s82 offers settings for manual control over the PCM reconstruction filters and roll-off filters. These settings are available from the Settings Menu - Audio Optimizations.

By default all audio optimization settings are set to automatic control.

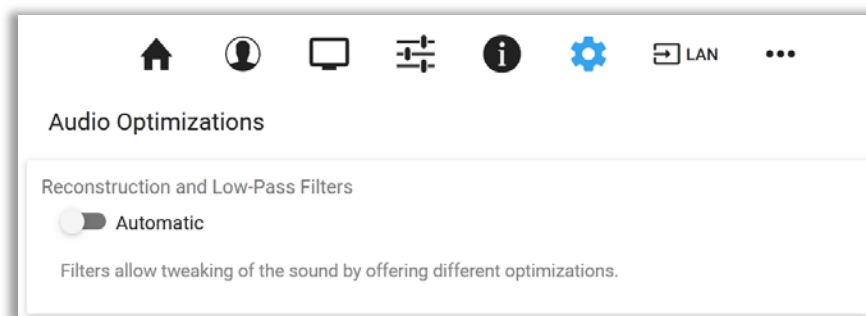

Turn off the Automatic switch to enable manual control.

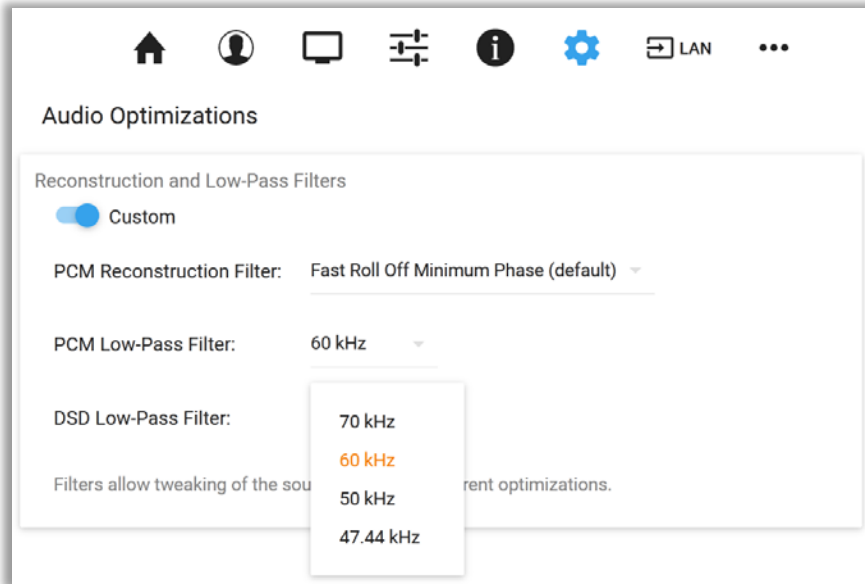

Advanced Settings - SPDIF and TOSLINK Lock

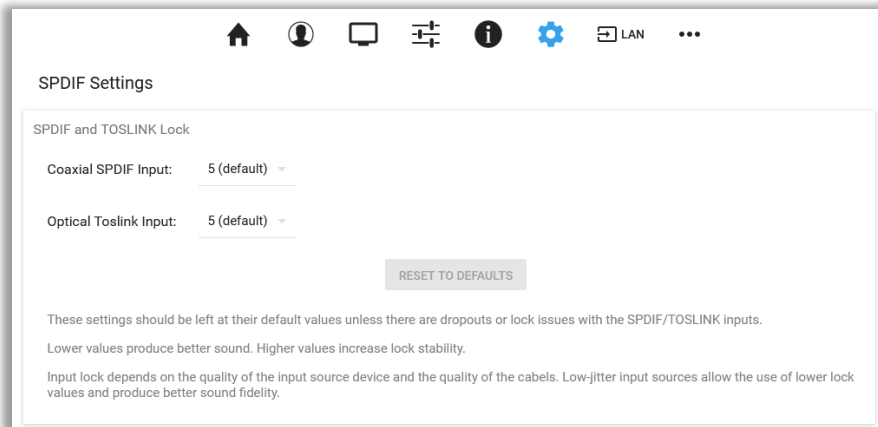

The SPDIF and TOSLINK inputs are configured by default to provide optimal sonic fidelity. If you experience interruptions, dropouts or lock issues with input sources that may exhibit high jitter, increase the values until you achieve a stable connection. SPDIF settings are available from the **Settings Menu**.

Advanced Settings - DAC Reset and Line Outputs control

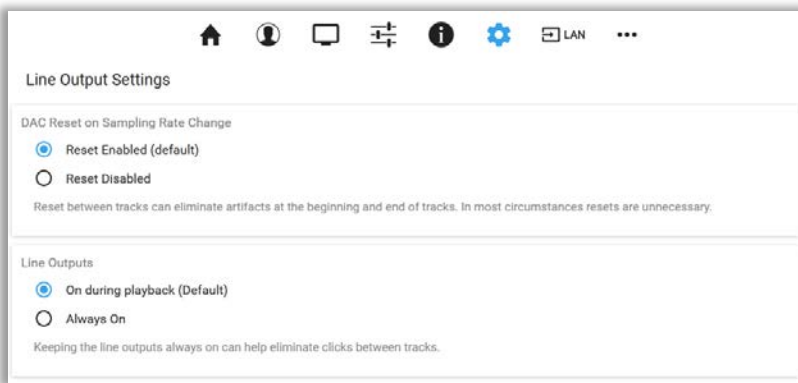

DAC Reset and Line Outputs control settings are available from the **Settings Menu**.

DAC Reset and Line Output Settings customize the behavior of the ES9038PRO DAC chip and the output stages when playback transitions from track to track. Depend on the player application and the power amplifier that you are using you may need to adjust these setting to eliminate intermittent soft clicks between tracks.

Note that clicks at the end of track may be caused by other factors beyond our control. These include errors during the mastering process of music files and external DSP processing.

Volume Control for LAN, SPDIF and Optical Inputs

There are two pages for volume control. A Simplified volume control page is available by clicking or tapping the three-sliders button on the Main Menu.

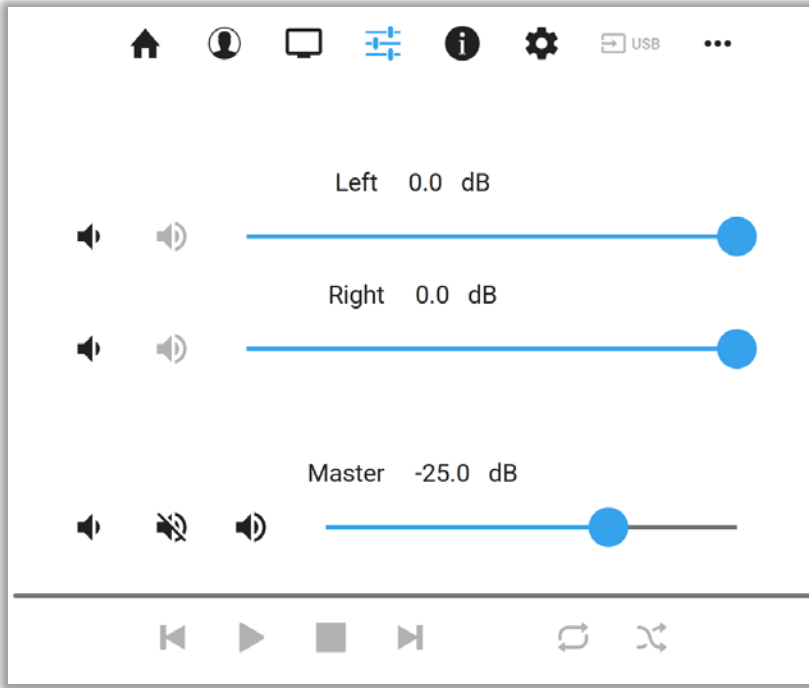

Advanced volume control page is available from the **Settings Menu**. In addition to volume control and channel trimming, it allows for saving and reloading volume configuration presets.

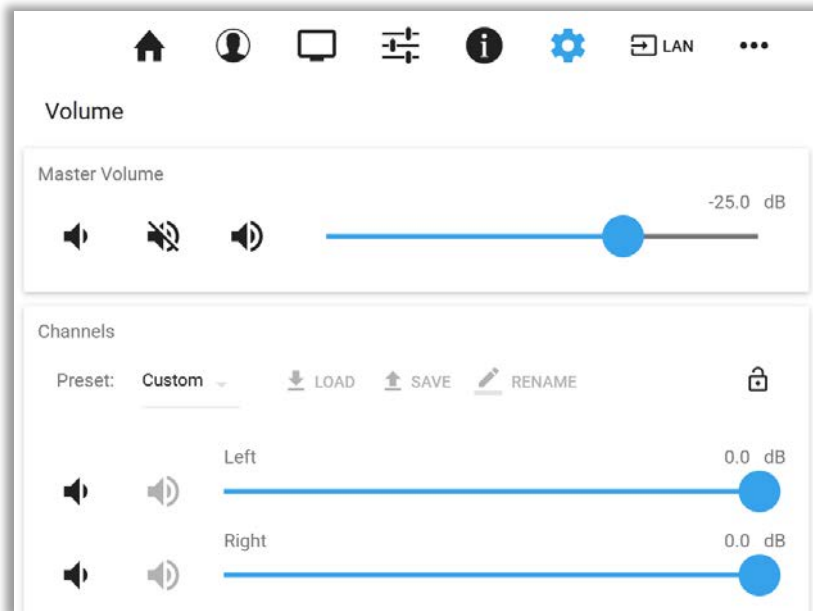

The volume control sliders are available when one of the **LAN**, **CBL** or **OPT** inputs is active. When the **USB** Input is selected, the volume sliders become grayed out and the s82 volume is controlled from the connected computer with the Windows Dashboard.

Volume levels for individual channels (volume trimming) often need to be adjusted when different audio zones with different speaker configurations are used. Adjustments may be needed for recordings with different channel balance. The Volume Presets make it possible to save channel volume levels to named profiles and to conveniently reload them as needed.

The exaSound s82 Mark II features ZeroResolutionLoss™ hardware volume control architecture. Audio data is streamed at 0dB over the USB and LAN connections and volume control is implemented by the ES9038PRO monolithic DAC. This approach preserves the maximum possible signal to noise ratio. The volume level changes in steps of 0.5 dB.

Volume can be controlled in several ways:

- From the volume knob on the s82 front panel.
- With the IR remote control.
- From iPad, iPhone or Android device. Compatible apps include Roon Remote, Tidal, Mconnect HD, Kazoo, UPnP control points like Bubble UPnP and Hi-Fi Cast.
- Web user interface pages are used to control the master volume and to trim the individual channel levels. This is possible when one of the **LAN**, **CBL** or **OPT** inputs is active.
- **Windows Dashboard** is used to control the master volume and to trim the individual channel levels when the **USB** input is active.

The s82 Streaming DAC implements unique 4-way volume synchronization. No matter which method is used to change the volume, all volume sliders in apps, the DAC display and the DAC web interface are kept in sync.

The sound can be muted by pressing the Mute button on the s82 front plate, the **Mute** switch on the **Dashboard** or with the IR remote control. Pressing or clicking **Mute** again restores the previous volume level.

Note: AirPlay devices can control the s82 Mark II volume; however there is no volume synchronization when volume is changed from the s82 Mark II. You should use the volume buttons in your Apple device. AirPlay volume control steps are less precise compared to other audio streaming technologies.

Note: Volume changes initiated by the third-party Bluetooth devices are not synchronised.

Volume Bypass

When the volume is set to 0dB, the hardware volume control is turned off and the s82 Mark II enables Volume Bypass Mode. To activate Volume Bypass:

- Set the master volume to 0dB.
- Set the volume sliders for all channels to 0dB.

- For USB connections to Windows computers set all volume sliders on the Windows Dashboard to 0dB.

Maximum Volume Limit

Use the **Maximum Volume Limit** setting to prevent accidental playback at volume levels that are too loud.

- The **Maximum Volume Limit** setting for the **LAN**, **CBL** or **OPT** inputs is located on the General Settings page of the Web user interface.
- The **Maximum Volume Limit** setting for the **USB** input is available from the right-click menu of the exaSound icon on Windows.

UPnP Server and Music Library

The exaSound s82 Mark II has a built-in UPnP server. It works with the music files stored on the internal SSD drives and on USB drives connected to the s82. Playback is controlled with apps like Mconnect Player HD, Bubble UPnP, Hi-Fi Cast, Kazoo and others.

The UPnP server scans internal SSD and attached USB drives for audio files. Metadata from the discovered files, like album, artist, and cover art are organized in media library which is stored on the internal SSD drive.



UPnP Tab on the General Settings page

When an USB drive is attached for the first time to the s82 Mark II, or when music files are added or removed, you have to update the UPnP library. From the web user interface, go to the **General Settings** page and on the UPnP Music Library tab click the **Update** button.

You can recreate the entire library with the **Rebuild** button.

The **Automatic Update** option keeps the library current when music files are copied, moved or deleted.

Scanning large drives may take a while. The UPnP server is available only when music files are present on the s82 storage drives. While preparing a USB drive for use with the s82 Mark II, make sure to empty the Recycle Bin/Trash Can. The s82 Mark II may find and include in the media libraries files that are not permanently deleted.

See **Sharing Attached USB Drives on the Network** for instructions how to copy files over the home network to the USB drives connected to the s82 Mark II.

	To avoid accidental data loss we recommend powering down the exaSound s82 Mark II before disconnecting a USB drive.
	Always maintain a backup copy of your music files. Never disconnect a USB drive during playback.

CD Ripping

The CD Ripping feature makes it easy to rip audio CDs and to use the ripped files with Roon. It relies on Roon for metadata availability and accuracy.

Advanced users interested to maintain control over the steps of the ripping process and the metadata quality and consistency will obtain best results by using third-party manual ripping applications on Mac and Windows computers.

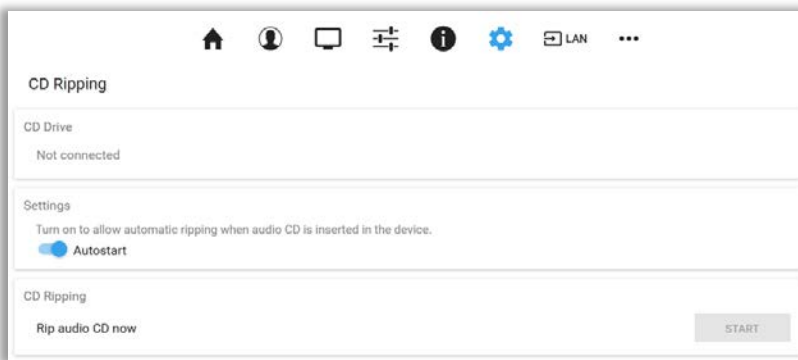

The **CD Ripping** page is available from the **Settings Menu**.

Here is an overview of the CD Ripping process:

1. When an external CD drive is connected to the s82 via USB, the **CD Ripping** page will display in the top tab a disk icon and the model of the drive. If the model name is not displayed then your drive is not supported.
2. When a music CD is inserted in the drive, the disk icon will display a note next to the disk. An attempt will be made to retrieve metadata for the CD from open-source music databases. These include album name, album art, track names, performers, composers etc. This is a preliminary step, the metadata may not be available and may not be completely accurate.
3. CD ripping can be started with the **Start** button or by using the **Autostart** option.
4. An attempt will be made to read your CD with the maximum possible accuracy. Since the Red Book format does not allow for error checking and correction, the software may attempt to read the CD multiple times and will attempt to correct reading errors. Depend on the capabilities of your CD drive and the quality and the condition of the CD, the ripping process can be quick or it can take a while.
5. The ripping process may be aborted if quality ripping is not possible. The ripped files will become visible on the SSD or USB disk storage after the ripping process of the entire CD is completed.
6. Files are copied to the first internal SSD or connected USB disk with sufficient space, in a sub-folder located in the root of the disk, for example: `\\s82\Disk1\CD\` or `smb://s82/Disk1/CD/`. When the disk space on the drive becomes insufficient, a new CD folder will be created on the next available drive.

7. Ripped files for each CD will be placed in a separate subfolder of the CD folder. Some CDs subfolders will have the corresponding CD title and some will be named as "Unknown Album NNN".
8. s82 makes the attached USB drives available as network shares on the home network. See the **Sharing Attached USB Drives on the Network** section of this guide for step by step instructions.
9. Ripped files stored on the internal SSD drives become automatically available in Roon.
10. To make the ripped files stored on connected USB drive available in Roon, the **CD** folder on the connected USB drive must be configured in the **Roon Settings** as a **Storage location**.
11. Roon will scan the ripped files and will perform a second step of metadata identification. The ripped CD albums will be represented in the Roon library with the metadata retrieved from the Roon cloud service. Roon also allows for manual editing of metadata.
12. Note that the metadata retrieved by Roon will be stored only in the Roon library. The folder names and the file names will not be corrected on the disk drive. The metadata retrieved by Roon will not be saved in the music files. The s82 UPnP server will not be able to display the metadata retrieved from the Roon cloud service. This is how Roon works and this makes the ripped files less usable with other players.
13. It is possible to use the Roon Export Playlist feature to make a new copy of the ripped CD files that will have proper folder names, file names and Roon-retrieved metadata.

Bluetooth Audio Streaming

The s82 Mark II offers playback for Bluetooth audio streamed from phones and tablets. s82 supports the SBC music codec.

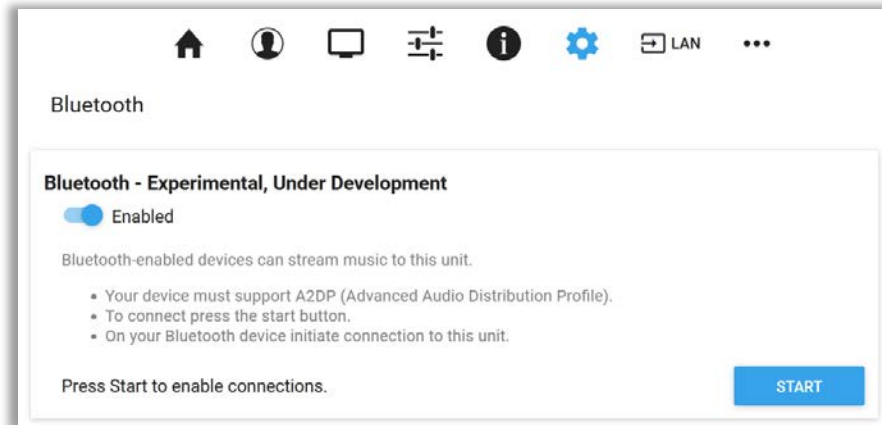

The Bluetooth page is available from the **Settings Menu**.

To stream audio via Bluetooth from your device:

- Enable Bluetooth streaming.
- Press the Start button and follow the instructions on the s82 Web user interface.
- Connect your Bluetooth device to the s82 and play music.

Web Streaming via HDMI - Experimental

Firmware update 49 introduces Web streaming support for YouTube, YouTube Music, Qobuz and TuneIn Radio. YouTube support includes the video experience.

- Web Streaming requires a TV or HDMI monitor, USB keyboard and mouse to be connected to the exaSound s82 Mark II. It is convenient to use a keyboard/mouse pair that shares the same wireless receiver.
- The exaSound Web user interface will be displayed on the connected TV or monitor.
- Open the **General Settings** page, scroll down to the bottom and enable "Web Streaming via HDMI".
- The screen will refresh and you will see a column of icons along the left edge of the display.

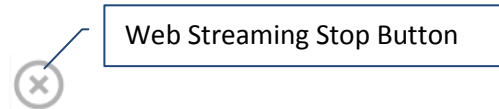
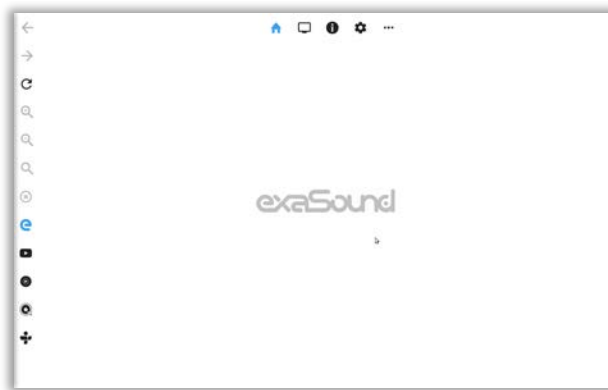

- Use the new icons on the left the way you use any Web browser. You will see the traditional navigation buttons, zoom controls and the icon shortcuts for YouTube, YouTube Music, Qobuz and TuneIn.

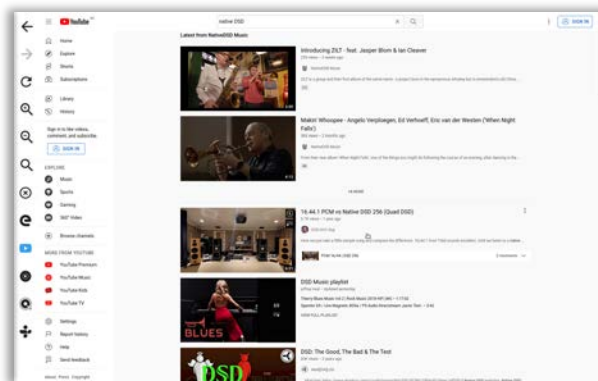

- The exaSound logo button will allow you to get back to the exaSound Web UI settings pages.
- You have to press or click the Stop button to cancel Web Streaming playback before using other players or streaming sources. It takes few seconds to stop web streaming. When the DAC is released, you will see "---" on the DAC display.
- Use the F11 on the keyboard to cancel full-screen mode.

- You can create accounts and login to each streaming service.

The new Web Streaming features are experimental and development continues.

Remote Support and Help

Remote Support and Help resources are accessible via the three-dots button on the right side of the Main Menu.

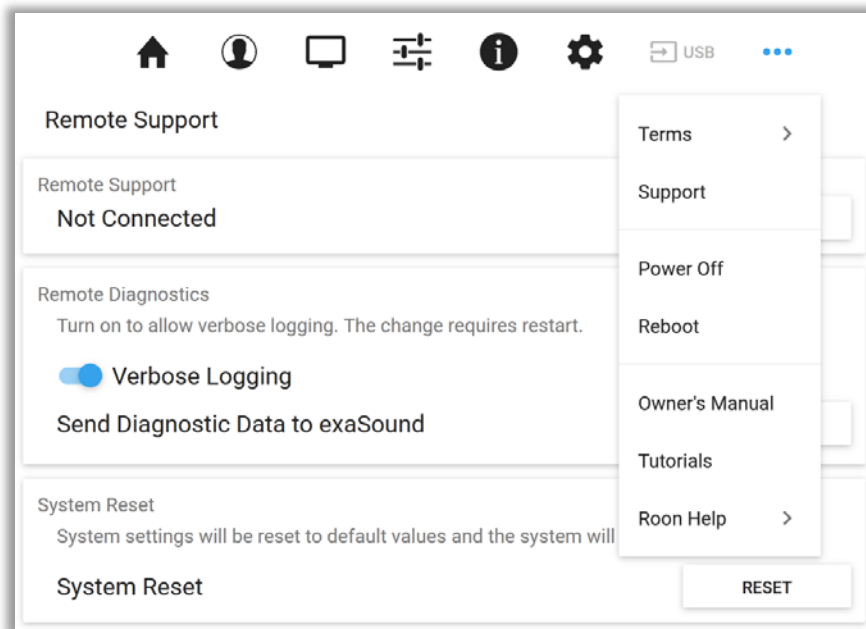

Remote support connections

Remote support connections are used by exaSound technical personnel for troubleshooting, collecting error logs and performance data. Remote connection is possible only when it is initiated by the s82 Mark II owner by pressing the **Start/Stop** button on the **Remote Support** tab.

Establishing the connection may take up to 10 seconds. Please email the displayed Support ID to the exaSound support representative. It is used to identify your s82 Mark II.

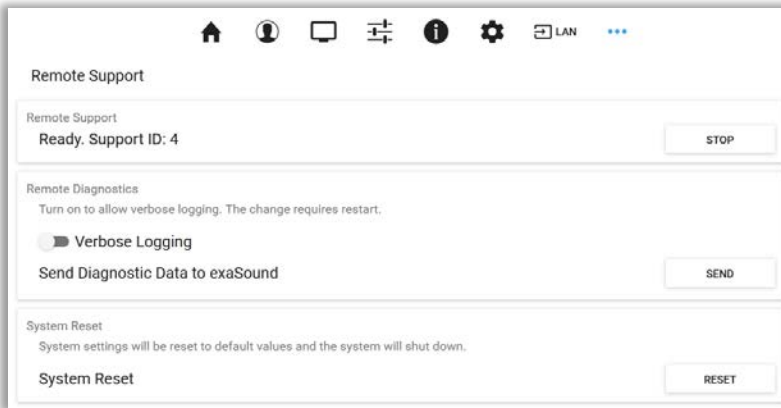

Windows ASIO Drivers Step-by-step Setup Guide

PC System Requirements

- Operating systems:
 - Windows 11
 - Windows 10
 - Windows 8
 - Windows Server 2012 R2
 - Windows 7, 32 or 64 bit
- USB 2.0 / USB 3.0 interface
- 8 GB of RAM

Windows ASIO Driver Installation

1. Windows ASIO driver installation is not required if you are using the Roon Core built in the s82.
2. Use the username / password that we've emailed you with the shipping confirmation email to login to support.exasound.com.
3. Download the latest version of the exaSound Windows ASIO Driver. Don't use setup packages downloaded from other websites.
4. Don't connect the s82 DAC to the PC until the driver is installed. If you've connected the device already, disconnect it.
5. Unzip the installation package and double-click on *exaSoundN1-5-3-54-Setup.exe*. (The driver version may be higher). Follow the instructions. In most cases you just need to accept the defaults on the following screens.

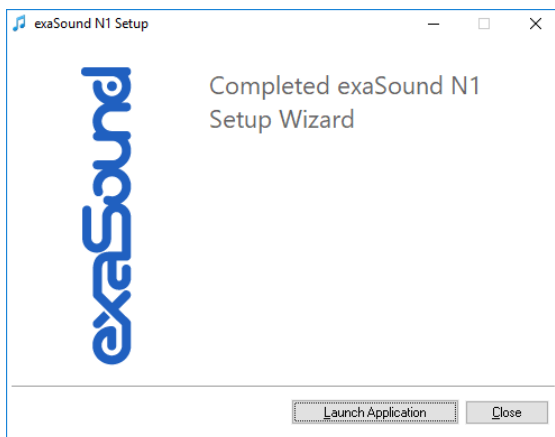
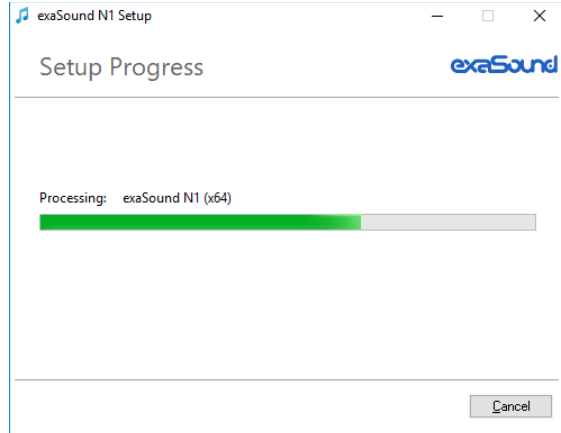
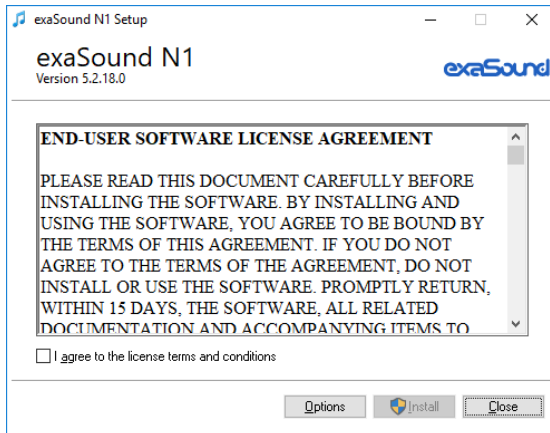

6. Upon completion of the Windows ASIO driver installation you will see the exaSound Dashboard Icon in the System Tray area next to the clock.

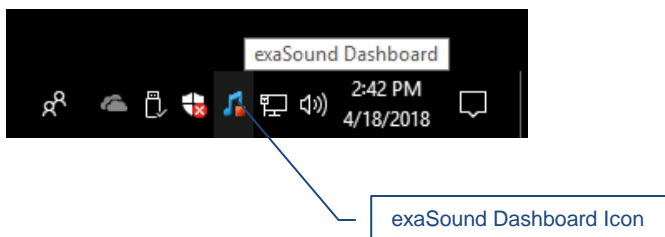

7. If you don't see it, right-click on the clock and select **Taskbar Settings** from the menu.

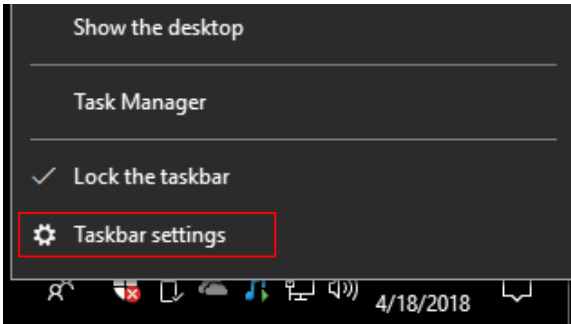



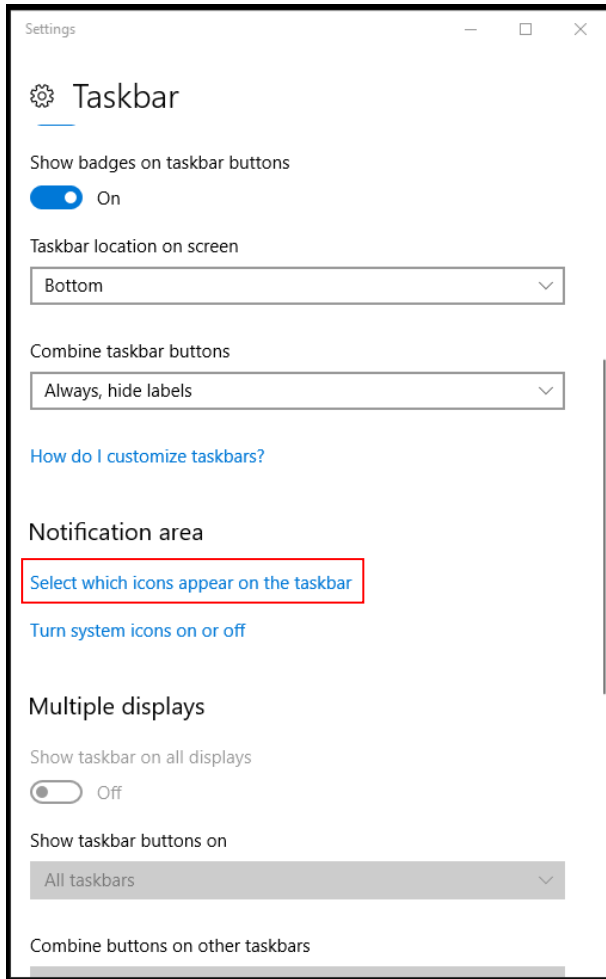

8. On the Taskbar Settings window click on Select **Which Icons Appear on the Taskbar**.

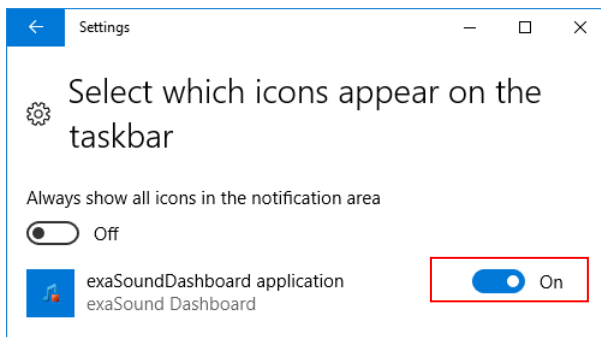

9. Scroll down to the exaSound s82 Dashboard icon and set the toggle to **On**.



10. Connect the USB cable between the s82 DAC and the PC.
11. Select the **USB** Input of the s82 DAC. The exaSound Dashboard will detect the USB connection.
12. You should be able to see the exaSound s82 Dashboard icons at all times. The Icon changes to indicate playback, and displays an exclamation mark when the USB connection is unavailable:

	exaSound Dashboard
	<i>Stop</i> Icon
	<i>Play</i> Icon
	USB Cable Disconnected or USB Input Not Selected

13. Close all programs and reboot Windows. Some ASIO players may not recognise the driver if you omit this step. If you don't restart Windows you may get an error message: "Hardware not present".

Using the s82 DAC with USB connection to Windows Computer

Using the Asynchronous USB Input - Windows



Before turning your amplifiers ON, always check the s82 DAC front panel to make sure that the volume level is safe.

- When the USB input is active, the s82 DAC can be controlled from the front panel buttons, using an IR remote control or from the computer screen. The Web User interface is unavailable.
- Make sure that all cables are connected. Turn on the unit using the **Power** button on the front panel or with the remote control. The power LED will light up. After 30 to 40 seconds the s82 will boot and the display will turn on.
- Use the Input Select button on the front plate, the IR remote Input Select buttons or the Web Dashboard to switch to the USB input.
- Click on the exaSound s82 Dashboard Icon in the System Tray area next to the clock.

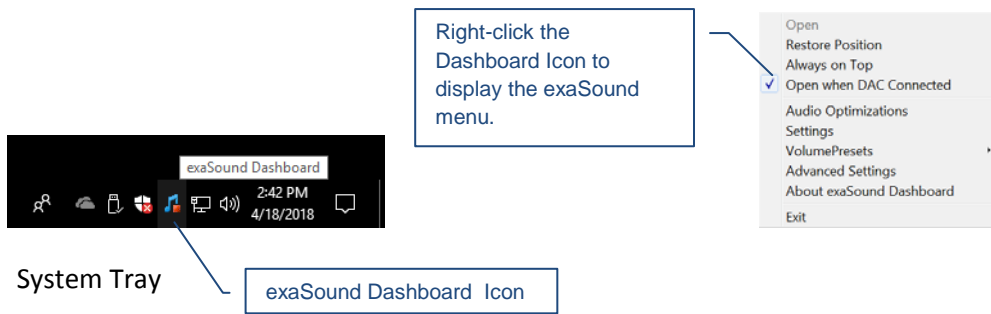

- You will see the exaSound s82 Dashboard window.

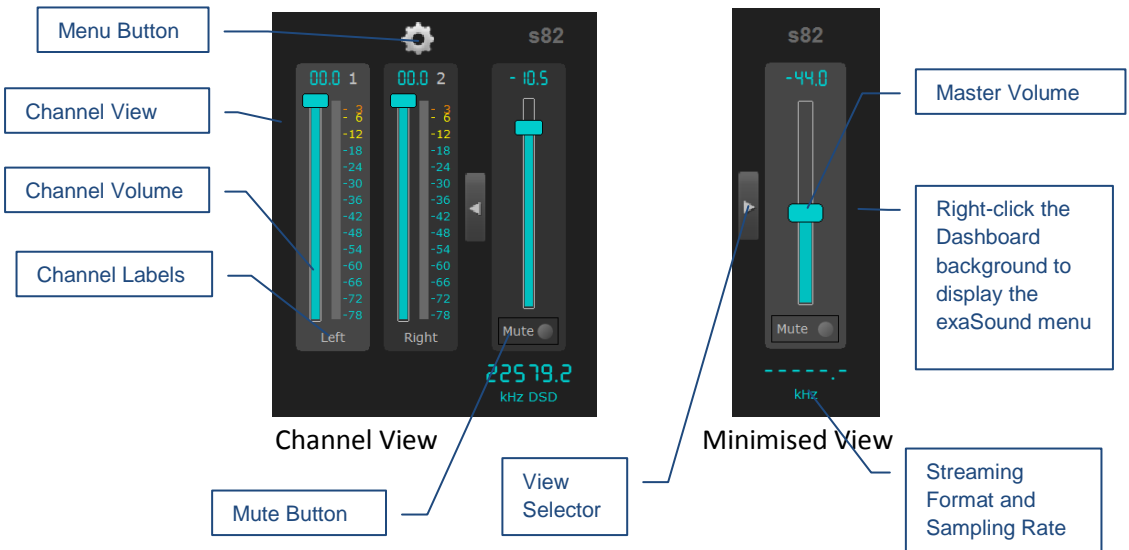

Note: Level indicators are inactive in DSD mode.

- During playback the current sampling rate and stream format are displayed under the master volume slider.
- You can customize the channel labels: Select a label with the mouse and edit the channel title. Press **Enter** to save or **Cancel** to discard the changes.
- Use the arrow button between the Right channel and the master volume to toggle between **Channel View** and **Minimised View**.
- Use the **X** button in the top right corner to minimize the exaSound Dashboard window.
- Use the gear button to display the Settings Menu.

Use the sliders on the exaSound s82 Dashboard window to control the volume for individual channels and the master volume. The sliders can be controlled in several ways:

- By left-clicking and dragging a slider.
- By positioning the mouse cursor over a channel and turning the mouse wheel. When the mouse cursor is rested over the channel area the background color changes to indicate that the channel is active.
- By selecting a channel with the mouse and using the **Up** and **Down** arrow keys on the keyboard.

JRiver / JRemote Volume Synchronization Plug-in - Windows

The exaSound Volume Synchronization Plug-in allows JRiver for Windows and JRemote to access the hardware volume control built in all exaSound DACs when a USB connection is used for playback. There is no need to install the plug-in when the s82 Mark II built-in Roon Core is used.

- Moving the JRemote or JRiver volume slider changes the master volume slider on the exaSound Dashboard.
- Changing the master volume with the exaSound Dashboard adjusts the JRemote / JRiver volume sliders.

Installation Instructions:

1. Run the exaSound plug-in Setup.
2. Restart JRiver.
3. You will see the exaSound plug-in listed in JRiver under Services & Plug-ins. Select the exaSound plug-in and use the checkbox to enable or disable volume synchronization.
4. Click on the Volume Options icon on the left side of the Jriver volume slider.
5. Select Enable Volume When Bitstreaming.
6. From the same menu select System Volume or Application Volume.

Check the *Guides* section of the exaSound Blog for step-by-step configuration instructions for the exaSound Volume Synchronization Plug-in: exasound.com/Blog.aspx

Roon Volume Synchronization Plug-in - Windows

The Roon Volume Synchronization Plug-in allows Roon for Windows to access the hardware volume control built in all exaSound DACs when a USB connection to the DAC is used for music playback. There is no need to install the plug-in when the s82 Mark II built-in Roon Core is used.

- Moving the Roon volume slider changes the master volume slider on the exaSound Dashboard.
- Changing the master volume with the exaSound Dashboard adjusts the Roon volume slider.

Installation Instructions:

1. Download and unzip exaSound-Roon-Volume-Plugin-Setup.zip.
2. Double-click exaSoundRoonVolumePlugin Setup 1.0.1.msi to start the setup and follow the instructions. The version of the setup package can be higher.
3. You will see the icon of the exaSound Volume Plug-in for Roon on the system tray (next to the clock).
4. Start Roon and from the menu go to Settings. Click on the Extensions tab.
5. You should see the exaSound Volume Plug-in in the list of available extensions.
6. Click on the Audio tab in the Roon Settings window.
7. From the list of local audio zones find the zone configured for use with an exaSound ASIO driver.
8. Click or tap the settings icon for the zone and select Device Setup.
9. Open the Volume Control drop-down and select exaSound Volume: ASIO.
10. Tap or click on the Save button at the bottom of the Settings window.
11. From the list of local zones select an audio zone configured for use with exaSound ASIO driver.
12. Try changing the Roon volume. You should see the volume level changes on the display of your exaSound DAC.

Step-By-Step Player Configuration Instructions - Windows

ASIO-enabled player apps compatible with the s82 DAC include Roon, HQPlayer, JRiver Media Center and Foobar2000. Step by step configuration instructions are available in the Guides section of our blog: exasound.com/Blog.aspx

Using Player Apps without ASIO Support

Player apps without ASIO support require the use of third-party WASAPI to ASIO bridge applications like VB-Audio ASIO Bridge available as free download from vb-audio.com/Cable/.

JRiver Media Center offers advanced WASAPI to ASIO bridge functionality.

Playing Music from SPDIF Sources

The s82 DAC makes it possible to enjoy greatly improved level of sonic clarity and fidelity from SPDIF sources. The sonic improvement is the result of the outstanding jitter cancelling capability, superb signal to noise ratio, and low distortion levels of the s82 DAC.

You can connect up to two SPDIF devices, such as disk players and music servers.

To use SPDIF sources:

1. Select SPDIF input by pressing the **Input** button on the device front panel, by using the **Previous Input / Next Input** buttons on the remote control or with the **Input Selector** on the exaSound Web Dashboard.
2. The s82 front panel display will flash a **Changing Input** message.
3. The s82 front panel will display information about the input in use, the current sampling rate, and the master volume level.



Controlling jitter cancelation for SPDIF Sources

Some consumer-grade audio sources and TVs have significant jitter on their optical (TOSLINK) outputs. The exaSound s82 DAC is preconfigured for maximum sonic fidelity and may not be able to lock on jittery coaxial SPDIF and optical TOSLINK sources. You can increase the jitter tolerance of the s82 DAC:

1. Connect the SPDIF and optical sources to the corresponding **CBL / OPT** inputs of the s82 DAC.
2. Select the s82 **CBL** or **OPT** input that you need to configure and play music.
3. Navigate your web browser to the s82 Mark II Web User Interface. By default the address is s82.local. Open the menu and select the **SPDIF Settings** page.
4. Select the lowest Lock value that provides stable playback.

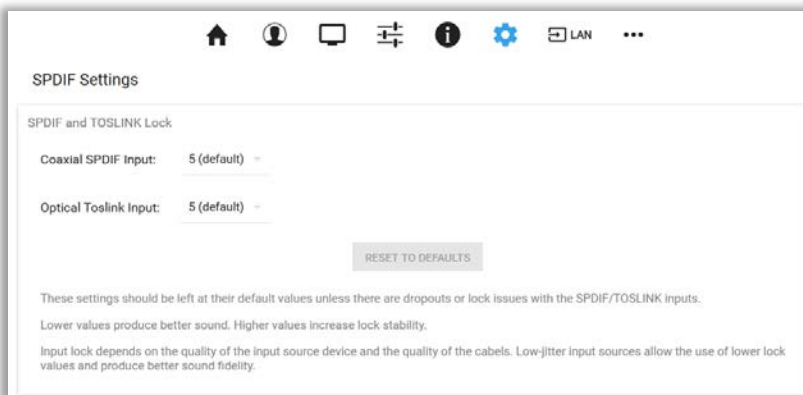

IR Remote Control Setup

The s82 DAC is programmed to work with the supplied remote control. You can reprogram the s82 DAC to work with a different IR remote control. The exaSound s82 DAC can learn to recognise commands from most infrared remote controls using Sony and NEC IR protocols.

Use the following procedure to change remote control button assignments or to pair the s82 DAC with a different remote control:

1. Power on the s82 DAC. Make sure that the unit is not in playback mode.
2. Press the **Setup** button.
3. Press the **Mute** button to confirm the remote control learning mode, or wait a moment to cancel the operation.
4. Point the remote control to the s82 DAC display. Follow the prompts on the s82 display. Press and hold down the remote control buttons for about one second during each step below to assign functions to them.
5. Press the remote control button for increasing the volume.
6. Press the remote control button for decreasing the volume.
7. Press the remote control button for selecting the next input.
8. Press the remote control button for previous input.
9. Press the remote control button for turning the unit on and off.
10. Press the remote control button for mute.
11. Press the remote control button for turning the display light on and off.
12. Wait until the remote control configuration is saved. Your s82 DAC is now paired for use with the new IR remote control.

A rectangular display with a black background and blue text. The text reads "Press rem cntrl for Vol +".

A rectangular display with a black background and blue text. The text reads "Press rem cntrl for Vol -".

A rectangular display with a black background and blue text. The text reads "Press rem cntrl for next input".

A rectangular display with a black background and blue text. The text reads "Press rem cntrl for prev input".

A rectangular display with a black background and blue text. The text reads "Press rem cntrl for power".

A rectangular display with a black background and blue text. The text reads "Press rem cntrl for mute".

A rectangular display with a black background and blue text. The text reads "Saving".

Specifications

Roon Server Module	Intel i5 CPU, 16GB RAM, 2TB SSD storage upgradable to 6TB
D/A Converter IC	ESS Technology ES9038PRO 32-bit, PRO series
PCM Sampling Rates - USB, Network Streaming	44.1kHz, 48kHz, 88.2kHz, 96kHz, 176.4kHz, 192kHz, 352.8kHz, 384kHz
DSD Sampling Rates: <ul style="list-style-type: none"> • USB - Windows ASIO • LAN - Network Streaming Notes: ASIO Compatible player like Roon, JRiver and HQPlayer is required on Windows.	Native DSD DSD64: 2.8224MHz; 3.072MHz DSD128: 5.6448MHz; 6.144MHz DSD256: 11.2896MHz; 12.288MHz DSD 512: 22.5792MHz; 24.576MHz
PCM Sampling Rates - SPDIF Coaxial IN1 CBL, Stereo	PCM 44.1 kHz, 48 kHz, 88.2 kHz, 96 kHz, 176.4 kHz, 192 kHz
PCM Sampling Rates-SPDIF Optical (TOSLINK) IN2 OPT, Stereo	PCM 44.1 kHz, 48 kHz, 88.2 kHz, 96 kHz
Total Harmonic Distortion + Noise	0.00021% @ 1kHz, 0dBFS
Total Harmonic Distortion	0.00014% @ 1kHz, 0dBFS
Intermodulation Distortion	-128db 0.00004% @ 19kHz + 20kHz 0 dBFS 2nd order IMD
Signal-to-Noise Ratio	Balanced: 123.8 dB, A-weighted, 4.6 Vrms Unbalanced: 123.5 dB, A-weighted, 2.0 Vrms
DAC Master Clock Jitter	0.082 psec (82fsec) rms
Frequency Response	0Hz - 20kHz (-0.15dB) @ 44.1kHz / 48kHz sampling rates 0Hz - 30kHz (-0.15dB) @ 88.2kHz and higher rates
Phase	Non-inverting
Channel Separation, Typical	133dB @ 1kHz
Digital Inputs	Ethernet LAN, Wi Fi, USB, SPDIF Coaxial, SPDIF TOSLINK (optical), USB storage

Line Outputs	Balanced (XLR), Unbalanced (RCA), gold-plated contacts
Line Output Level	Balanced: 4.6 Vrms Unbalanced: 2 Vrms
Line Output Impedance	Balanced: 400 ohms Unbalanced: 200 ohms
Line Output Offset	< 5 mV
Headphone Amp Current Output	500 mA peak
Headphone Amp Output Impedance	2 Ohm, 20Hz-20KHz
Headphone Amp Output Voltage	0-6Vrms
Headphone Amp THD+N, typical	0.0012%, 1Vrms into 60ohms
Headphone Amp Intermodulation Distortion 1Vrms into 60ohms 19kHz + 20kHz 2nd order IMD, typical	-120db 0.0001%
Headphone Jack	Unbalanced: 1/4" TRS, SE
Volume Control	Four-way volume synchronization, Volume bypass Channel trimming Mute ZeroResolutionLoss™ volume control architecture provides all-time 0dB Full-Scale streaming Acceleration-sensing volume knob
Volume Control Step	0.5 dB
Volume Matching Between Channels	Better than 0.1 dB
Operating System Requirements, Windows USB / ASIO	Windows 11, Windows 10 x64, Windows 8 x86, Windows 8 x64, Windows 7, Windows XP ASIO compatible player required for all Windows platforms
USB Ports	Type A: 4x USB 3; Type C: 1xUSB 3; Type B: USB 2

Ethernet Interface	Gigabit Ethernet
Wi-Fi Interface	Intel® Dual Band Wireless-AC 7260 802.11 ac/n 2.4 GHz, 5 GHz Compliance PCI, CISP, FIPS, FISMA
IP Setup	IP4, DHCP, manual configuration
Wireless Security Mode	WPA-PSK2 AES (Home)
External Main Power Supply	<p>Switching Mode Power Supply Input: 100-240V AC, 1.4A, 50-60Hz Output: 12V DC, 6.25A 80W Max Compliance CE, FCC, RoHS, Safety CE,UL/cUL,FCC,TUV/GS</p>  <p>Meet Energy Star EPS2.0/ErP lot 7 Meet DOE Level VI High Reliability EMC Standard: EN55022 CLASS B / EN55024 CLASS B Over Current Protection Over Temperature Protection Over Voltage Protection</p>
Power Consumption	<75 W
Power Jack Diameter	Internal: 2.5mm External : 5.5mm
Enclosure	Premium machined and anodized aluminium mono-block Finish: Black
Dimensions (W x H x D)	17.5 x 2.625 x 9.64 inches (445 x 70 x 245 mm)
Weight	11.46 lbs (5.2Kg)
Package dimensions (W x H x D)	20.75 x 8.25 x 16.5 inches (525 x 209 x 423 mm)
Package Weight	15.2 lbs (6.9Kg)

Open-source Credits

We make extensive use of [open source software](#) for the various technologies, architectures, and interfaces that run on the exaSound s82 Mark II. In fact, we would be unable to offer the device as we envision it, at the current price, without these publically developed projects. The credit roll is available on the s82 Mark II Web Interface.



GNU General Public License (“GPL”)

Firmware incorporated into this product may include third party copyrighted software licensed under the GPL or Lesser General Public License (“LGPL”) (collectively, “GPL Software”) and not exaSound's Terms of Use available at <https://www.exasound.com/AboutUs/TermsofUse.aspx>. In accordance with the GPL, if applicable: 1) the source code for the GPL Software may be downloaded at no charge from <https://support.exasound.com>. Contact [Customer Support](#) for further information; 2) you may re-use, re-distribute, and modify the GPL Software; 3) with respect solely to the GPL Software, no warranty is provided, to the extent permitted by applicable law; and 4) a copy of the GPL is included herewith, may be obtained at <http://www.gnu.org/licenses/gpl-3.0.en.html>, and may also be found at <https://support.exasound.com>.

Modification of or tampering with the Software, including but not limited to any Open-source Software, is solely at your own risk. exaSound Audio Design is not responsible for any such modification or tampering. exaSound Audio Design will not support any product in which you have or have attempted to modify the Software supplied by exaSound Audio Design.

Safety Information

Explanation of Graphical Symbols

	The lightning flash with arrowhead symbol, within an equilateral triangle, is intended to alert the user to the presence of uninsulated “dangerous voltage” within the product’s enclosure that may be of sufficient magnitude to constitute a risk of electric shock to persons.
	The exclamation point within an equilateral triangle is intended to alert the user to the presence of important operating and maintenance (servicing) instructions in the literature accompanying the Device.



Important Safety Instructions



1. Read these instructions.
2. Keep these instructions.
3. Heed all warnings.
4. Follow all instructions.
5. Do not use this apparatus near water.
6. Clean only with dry cloth.
7. Do not block any ventilation openings. Install in accordance with the manufacturer’s instructions.
8. Do not install near any heat sources such as radiators, heat registers, stoves, or other apparatus (including amplifiers) that produce heat.
9. Do not defeat the safety purpose of the polarized or grounding-type plug. A polarized plug has two blades with one wider than the other. A grounding type plug has two blades and a third grounding prong. The wide blade or the third prong is provided for your safety. If the provided plug does not fit into your outlet, consult an electrician for replacement of the obsolete outlet.
10. Protect the power cord from being walked on or pinched, particularly at plug, receptacle, and the point where it exits from the apparatus.
11. Only use attachments/accessories specified by the manufacturer.
12. Refer all servicing to qualified service personnel. Servicing is required when the device has been damaged in any way, such as power-supply cord or plug is damaged, liquid has been spilled or objects have fallen into the device, the device has been exposed to rain or moisture, does not operate normally, or has been dropped.

Precautions

- Before connecting the AC power adapter cord to the device, make sure the voltage designation of the power adapter corresponds to the local electrical supply. If you are unsure of your power supply, contact your local power company. The acceptable power input range is AC ~ 100V-240V, 50/60Hz

- The device is still receiving power from the AC power source as long as it is connected to the wall outlet, even if the device itself has been turned off.
- Unplug the power adapter if you are not going to use the device for an extended period of time. Hold the power adapter when unplugging. Do not pull on the cord.
- The power adapter is used as the mechanism for cutting off power, therefore make sure it is easy to unplug.
- To ensure proper ventilation around this product, do not place this product on a sofa, bed or rug.
- High temperature will lead to abnormal operation of this device. Do not expose this device or batteries to direct sunlight or near heating objects.
- When moving the device from a cold location to a warm one, or vice versa, moisture may condense on components inside the device. Should this occur, the device may not operate properly. In such a case please turn the device off for 1-2 hours to facilitate moisture evaporation.

	<p>WARNING: TO REDUCE THE RISK OF FIRE OR ELECTRIC SHOCK, DO NOT EXPOSE THIS DEVICE TO RAIN OR MOISTURE. DANGEROUS HIGH VOLTAGES MAY BE PRESENT INSIDE THE ENCLOSURE. DO NOT OPEN THE CABINET. REFER SERVICING TO QUALIFIED PERSONNEL ONLY. THE DEVICE SHALL NOT BE EXPOSED TO DRIPPING OR SPLASHING AND THAT NO OBJECTS FILLED WITH LIQUIDS, SUCH AS VASES SHALL BE PLACED ON THE APPARATUS.</p>
	<p>WARNING: CHANGES OR MODIFICATIONS NOT AUTHORIZED BY THE MANUFACTURER CAN INVALIDATE THE COMPLIANCE TO REGULATIONS AND CAUSE THE UNIT TO BE NO MORE SUITABLE TO USE. THE MANUFACTURER REFUSES EVERY RESPONSIBILITY REGARDING DAMAGES TO PEOPLE OR THINGS DUE TO THE USE OF A UNIT WHICH HAS BEEN SUBJECT TO UNAUTHORIZED MODIFICATIONS OR TO MISUSE OR TO MALFUNCTION OF A UNIT WHICH HAS BEEN SUBJECT TO UNAUTHORIZED MODIFICATIONS.</p>
<p>FCC Statement</p>	<p>This equipment has been tested and found to comply with the limits for a Class B digital device, pursuant to Part 15 of the FCC Rules. These limits are designed to provide reasonable protection against harmful interference in a residential installation. This equipment generates, uses, and can radiate radio frequency energy and, if not installed and used in accordance with the instructions, may cause harmful interference to radio communications. However, there is no guarantee that interference will not occur in a particular installation. If this equipment does cause harmful interference to radio or television reception, which can be determined by turning the equipment off and on, the user is encouraged to try to correct the interference by one or more of the following measures:</p> <ul style="list-style-type: none"> • Reorient or relocate the receiving antenna. • Increase the separation between the equipment and receiver. • Consult the dealer or an experienced radio/TV technician for help. <p>Any unauthorized changes or modifications to this equipment would void the user's authority to operate this device. This device complies with Part 15 of the FCC Rules. Operation is subject to the following two conditions: (1) This device may not cause harmful interference, and (2) this device must accept any interference received, including interference that may cause undesired operation.</p>
	<p>This unit is compliant with Directive 2011/65/EC (RoHS) Restriction on Hazardous Substances,</p>

	<p>and is in conformity with the provisions of the EMC Directive 2004/108/EC. The following harmonized standards were applied:</p> <p>EN55022:2010/AC:2011 Class B</p> <p>EN61000-3-2:2006/A1:2009 and /A2:2009, EN61000-3-3:2008</p> <p>EN55024:2010 (IEC 61000-4-2:2008, IEC 61000-4-3-2006/A1:2007/A2:2010, IEC 61000-4-4:2004/A1:2010 , IEC 61000-4-5:2006, IEC 61000-4-6:2008, IEC 61000-4-8:2009, IEC 61000-4-11:2004)</p> <p>1999/5/ec - Radio and telecommunication Terminal Equipment Device (R&TTE)</p> <p>EN 60950-1, EN62311 - For Article 3.1(a): Health and safety of the user</p> <p>EN 301 489-1, EN 301 489-17 - For Article 3.1(b): Electromagnetic Compatibility</p> <p>EN 300 328, - EN 301 893 - For Article 3.2: Effective use of spectrum allocated</p>
	<p>This product, when no longer usable, when disposed off can't be treated as generic garbage, but must be disposed of at a collection point for recycling of electrical and electronic equipment, in compliance with the WEEE regulation (Waste of Electrical and Electronic Equipment).</p> <p>By making sure that this unit is correctly recycled, you will help preventing potential damages to environment and human health, which could be caused by the incorrect treatment of this product as generic garbage. Materials recycling helps conserve natural resources.</p>
	<p>We use our best efforts to ensure that information in this document is complete, accurate and current, but otherwise we make no representation concerning the same. We reserve the right to change or modify the information any time, without prior advice. It's up to the customer to ensure that the manual being consulted is the latest version.</p>
<p>Trade marks</p>	<ul style="list-style-type: none"> ▪ ZeroJitter™, GalvanicInfinity™, ENclusiv™, FemtoMaster™ and ZeroResolutionLoss™ are trademarks of exaSound Audio Design. ▪ Direct Stream Digital (DSD) is a trademark of Sony Corporation. ▪ Roon and Roon Ready and the Roon Labs logo are trademarks or registered trademarks of Roon Labs or Roon Labs's licensors. ▪ The MQA logo is a trade mark of MQA Limited. © MQA Limited 2018 ▪ Designed for Windows Media, Microsoft, HDCD, and the HDCD logo are trademarks or registered trademarks of Microsoft Corporation in the United States and/or other countries. ▪ Apple, Mac, AirPlay, iOS and OS X are trademarks of Apple, Inc. ▪ All other trademarks are the properties of their respective owners.

Limited One Year Warranty

exaSound's devices are warranted against defective workmanship or materials for one (1) calendar year from the original date of purchase. This warranty applies only to exaSound brand products manufactured by exaSound and sold to the original consumer by either exaSound or an exaSound authorized reseller. This warranty does not apply to exaSound brand products imported and sold by unauthorized dealers, distributors, or other sellers. exaSound may at its sole discretion, refuse to honour the warranty of any such unauthorized product that may be presented for service.

Warranty service can only be performed by exaSound. Devices which are defective must be shipped pre-paid and insured to exaSound for warranty service in accordance with our Return Policy published at <https://www.exasound.com/AboutUs/TermsOfUse.aspx>. For products that we verify to be eligible for warranty service, we will pay the shipping cost to return the Device to you via ground shipment.

If in our assessment the defect is covered by our Warranty, the defective item will, at our sole option, be repaired, replaced with the same item or its functional equivalent, or the purchase price will be refunded. exaSound in its sole and absolute discretion shall be the sole determiner of whether a product is in fact defective.

Replacement parts and products assume the remaining original warranty, or ninety (90) days, whichever is longer.

This limited warranty covers non-commercial use of this product, and shall not apply to the following, including, but not limited to: applications and uses for which this product was not intended; altered product or serial numbers; cosmetic damage or exterior finish; batteries and cable accessories; accidents, abuse, neglect, fire, water, lightning or other acts of nature; incorrect electrical line voltage, fluctuations and surges; failure to follow operating or maintenance instructions. exaSound does not warrant uninterrupted or error-free operation of the product. This limited warranty shall not extend to anyone other than the original purchaser of the product. It is non-transferable and states your exclusive remedy.

exaSound hereby expressly disclaims all liability for product defect or failure, that are due to normal wear, product misuse, physical tampering, abuse, product modification, improper product selection, non-compliance with any codes, misappropriation or the failure of the Device while being used for purposes for which it was not intended.

THE FOREGOING WARRANTY IS THE ONLY WARRANTY WITH RESPECT TO THE DEVICES AND WE MAKE NO OTHER WARRANTY WHATSOEVER, EXPRESS OR IMPLIED, REGARDING THE DEVICES INCLUDING MERCHANTABILITY AND FITNESS FOR A PARTICULAR PURPOSE. IN NO EVENT WILL EXASOUND, OR ITS AUTHORIZED RESELLERS BE LIABLE FOR INCIDENTAL, CONSEQUENTIAL OR SPECIAL DAMAGES, EVEN IF SUCH DAMAGES RESULT FROM NEGLIGENCE OR OTHER FAULT.

TO OBTAIN WARRANTY SERVICE, please follow these instructions:

- Contact exaSound customer service via email at CustomerService@exaSound.com with details of the defect claimed, product model, serial number, date and place of the original purchase.
- If it is determined that your product needs service, a Return Merchandise Authorization (RMA) number will be issued to you along with return instructions and address of an exaSound service center.
- Pack the product securely in the original packaging, with your assigned RMA number marked clearly on the outside of the package. Send the package pre-paid and insured to the exaSound to obtain warranty service.
- All returns must comply with our Return Policy displayed at <https://www.exasound.com/AboutUs/TermsOfUse.aspx>.

Information furnished by exaSound Audio Design is believed to be accurate and reliable; however, no responsibility is assumed by exaSound Audio Design for its use nor for any infringement of patents or other rights of third parties which may result from its use. exaSound Audio Design reserves the right to change specifications at any time without notice.

© 2010-2023 exaSound Audio Design, All rights reserved.